

H.264 Network Video Server

SVR610 / SVR610W / SVR610-PoE

User's Manual

Date: 7/20/2012

Firmware Version: V1.0.32

Content

Content	1
1. Preface	3
2. Product Specifications	3
3. Product Installation	5
A. Hardware Installation	5
Cable Connections	5
I/O Connections	7
B. Monitor Setting	9
C. IP Assignment	錯誤! 尚未定義書籤。
4. Live Video	12
5. Configuration	17
A. System	17
System Information	17
User Management	21
System Upgrade	23
System Logs	24
B. Video/Audio Setting	25
Video Format	25
Image Setting.....	28
Audio Setting	29
C. Network Setting	30
Network Setting	30
Wireless Setting.....	34
Mail / FTP / Samba Setting	37
PPPoE Setting	40
DDNS Setting	41
D. Event Handling	43
Event Setting	43
I/O Setting.....	49
Schedule.....	51
SD Card.....	53

6. Network Configuration	55
A. Intranet Only	55
Connects to PC Directly	55
Connects to an Exist LAN	56
B. Internet Only	57
Connects to ADSL with Fixed Public IP Address.....	57
Connects to ADSL with Floating Public IP Address (PPPoE).....	58
C. Intranet + Internet	60
Connects to Internet with Fixed Public IP Address.....	60
Connects to Internet with Floating Public IP Address.....	62
7. Factory Default	63
Compatible List of SD Card	64

1. Preface

This device is a 1 channel video server. It builds in web server. User views real-time video via IE browser. It supports H.264, JPEG and MPEG4 (3GPP Only) video compression which provides smooth and high quality video. The video can be stored in the SD card, and can be playback remotely by Microsoft Windows Media Player.

The PoE model built-in support for Power over Ethernet allows the video server to receive both data and power over a single Ethernet cable.

This device is an easy-to-use video server which can connect any kind of analogue camera to fit the customer's need.

2. Product Specifications

- H.264 / MJPEG / MPEG4 (3GPP Only) compression formats. Supports resolution up to 30/25 fps @ Full D1 (720x480 / 720x576)
- H.264 / MJPEG / MPEG4 (3GPP Only) triple streaming.
- Self-Contained HTTP Web Server providing Internet capability for remote access
- Wireless network connection (Wireless model)
- Built-in PoE splitter, support for Power over Ethernet (PoE model)
- Supports SD card for local recording
- 2-way audio
- RS-485 connection for remote Pan/Tilt/Zoom control
- Recorded files compatible with Microsoft Windows Media Player

Hardware	
CPU / RAM / ROM	ARM 9, 32 bit RISC / 256MB / 16MB
Video In / Out	1 in/ 1 loop back out (BNC connectors)
Audio In / Out	1 Line in/ 1 Line out (RCA connectors)
Digital I/O	2 Digital in / 2 Relay out
RS-485	1, for PTZ control
Power Supply	Normal & Wireless model: DC 12V, 1A PoE model (built-in PoE Splitter): Use PoE: PoE Injector (IEEE 802.3af) Or, use Power Adaptor: DC 12V, 1A
Power Consumption	Max. 4 Watt

Dimensions	W134 x H42 x D107 mm
Network	
Ethernet	10/ 100 Base-T
Wireless (Wireless model)	802.11b/g, supports WPA-PSK, WPA2-PSK, WEP 64/ 128 bit
Network Protocol	HTTP, TCP/IP, RTP/RTSP, 3GPP, SMTP, FTP, PPPoE, DHCP, DDNS, NTP, UPnP
System	
Video Resolution	NTSC: 720x480, 704x480, 352x240, 176x120 PAL: 720x576, 704x576, 352x288, 176x144
Compression Format	H.264 / MJPEG / MPEG-4 (3GPP only)
Frame Rate	Up to 30 FPS
Triple Streaming	Yes (2 for live view, 1 for 3GPP)
3GPP	Yes, Live view with 3G mobile phone
Video Bitrate Adjustment	CBR, VBR
Video Adjustment	Brightness, Contrast, Hue, Saturation, Sharpness
Image Snapshot	Yes
Privacy Mask	Yes, 3 different areas
Motion Detection	Yes, 3 different areas
Event Trigger	Motion Detection, Digital In
Triggered Action	Send Email, Send to FTP, Save to SD Card, Relay Out
Pre/ Post Alarm	Yes, configurable
Remote PTZ Control	Yes, via RS-485
Security	Password protection
Firmware Upgrade	HTTP mode, can be upgraded remotely
Connection	Up to 10 clients simultaneously
Audio	Yes, 2-way
SD card management	
Recording Trigger	Motion Detection, Digital In, IP Check, Network Disconnect
Schedule	Snapshot with schedule
Video Format	Video (AVI), Snapshot (JPEG)
Video Playback	Yes
Web browsing requirement	
OS	Windows 2000, XP, Vista, Windows 7
Web Browser	Microsoft IE V7.0 (32-bit) or above, Mozilla Firefox V6.0 or above, Opera V11.5 or above, Safari V5.1 or above, Google Chrome V13.0 or above
Suggested Hardware	Intel Core 2 Duo 1.66GHz, RAM: 1GB Graphic card: 128MB onboard RAM

* Specifications are subject to change without notice

3. Product Installation

A. Hardware Installation

Cable Connections

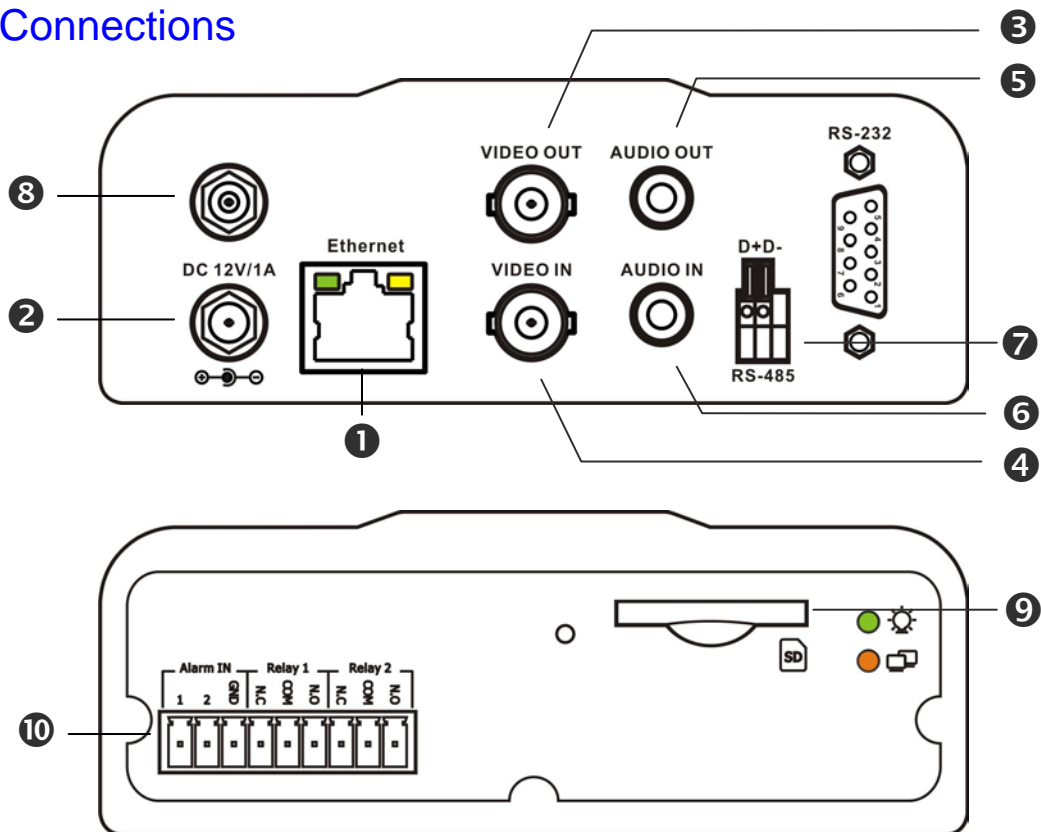

① Network Connector:	The RJ-45 connector allows connect the Ethernet cable.
② Power Jack:	To connect the DC 12V power adapter.
③ Video Out:	The BNC connector allows connect to the analog display to output analog video for locally monitoring.
④ Video In:	The BNC connector allows connect to the video signal of an analog camera.
⑤ Audio Out:	The RCA connector allows connect to an amplified speaker, you can hear the voice of the remote site from the speaker.
⑥ Audio In:	The RCA connector allows connect to a microphone or audio source, the voice will be transferred to the remote site via network.

⑦ RS-485 Connector:	This terminal block allows connect to a PTZ device.
⑧ Antenna Connector:	Available for Wireless model. To connect the included wireless antenna.
⑨ SD Card Slot:	Insert a SD card if you want to do the event recording (Video only) in the video server.
⑩ Digital I/O:	Digital In and Relay Out.

1. Connect the video and audio outputs of analog camera to the video server. If the analog camera is a PTZ device, connect the RS-485 for the remote PTZ control.
2. Connect the cable of Digital I/O, Video output, and Audio output if you want to use these functionalities.
3. Connect the wireless antenna for the Wireless model.
4. Connect Ethernet cable for network connection.
5. Connect power adapter to turn on the device.
6. If the device is PoE model, the power adapter is not necessary. The device will get the power from the PoE injector or PoE switch.

PoE (Power over Ethernet) is a technology that integrates power into a standard LAN infrastructure. It enables power to be provided to the network device, such as an IP phone or a network camera, using the same cable as that used for network connection. It eliminates the need for power outlets at the camera locations. Please follow the below figure for the connection.

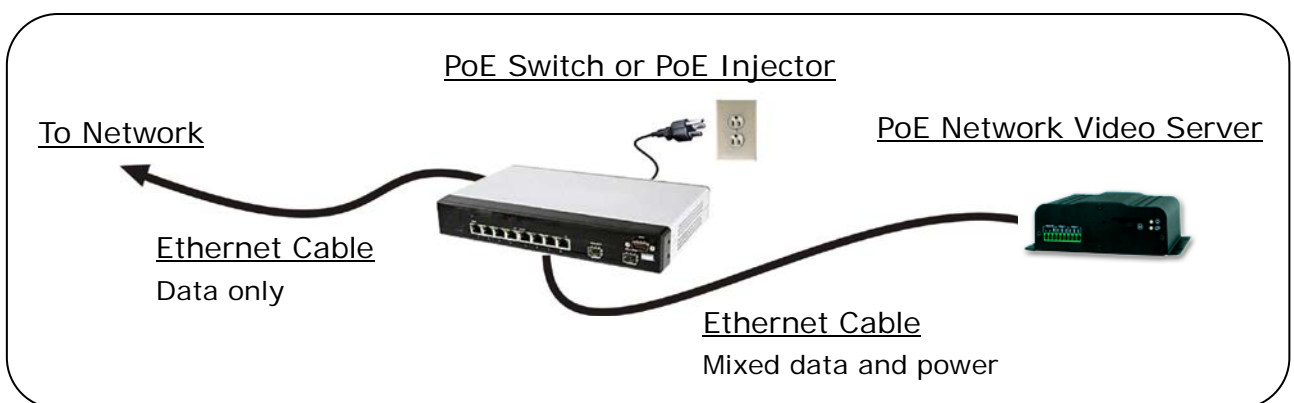

7. Set up the network configurations according to the network environment. For further explanation, please refer to [Network Configuration](#) chapter.
8. After finish the configuration for the very first time, if you want to use wireless network, plug out the Ethernet cable.

I/O Connections

I/O terminal connector – used in application, for e.g., motion detection, event triggering, alarm notifications. It provides the interface to:

- 2 sets of Digital Input (Alarm In + GND) – The digital inputs for connecting devices that can toggle between an open and closed circuit, such as PIRs, door/window contacts, glass break detectors, etc. When a signal is received the status changes and the input becomes active.
- 2 sets of Relay Output (N.O. + COM or N.C. + COM) – The output to Relay switch of the alarm device such as LEDs, Sirens, etc.

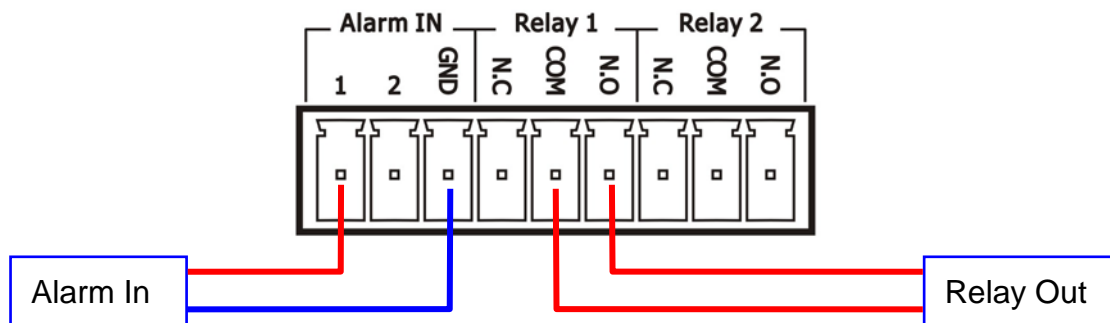

Digital Input (Alarm Input)

GND (Ground): Initial status is LOW.

Alarm: Max. 50mA, 12VDC.

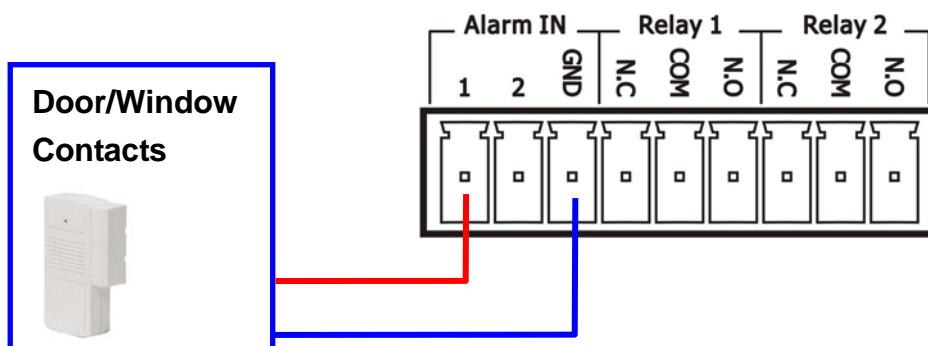

Relay output

COM: Common pin.

N.O. (Normally Open): Max. 1A / 24VDC or 0.5A / 125VAC.

N.C. (Normally Close): Max. 1A / 24VDC or 0.5A / 125VAC.

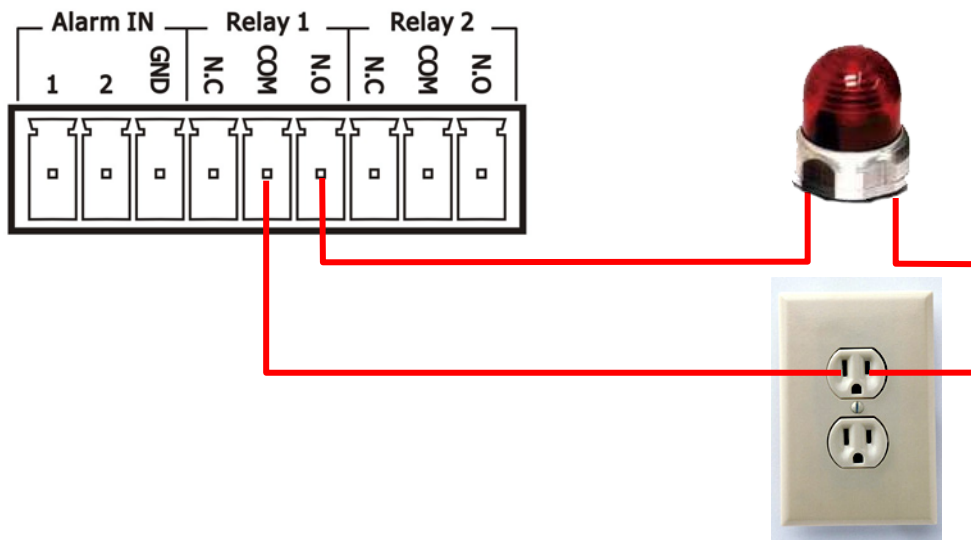

B. Monitor Setting

1. Right-Click on the desktop. Select “Properties”

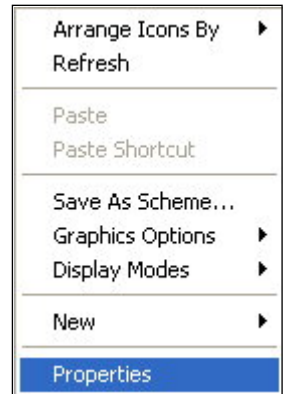

2. **Change color quality to “Highest (32bit)”**.

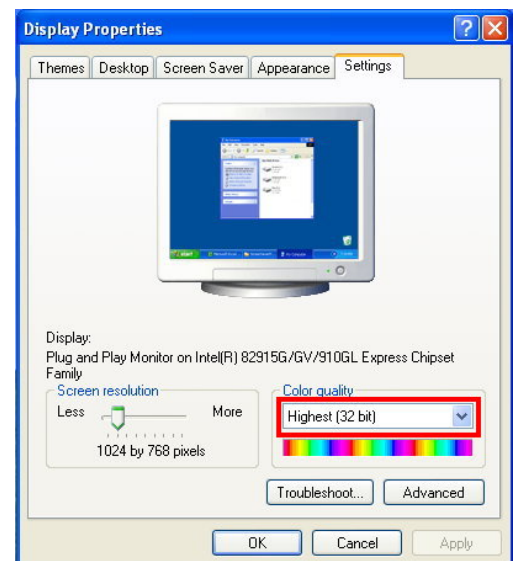

C. IP Assignment

- Always consult your network administrator before assigning an IP address to your camera in order to avoid using a previously assigned IP address.
- MAC Address: Each network camera has a unique Ethernet address (MAC address) shown on the sticker of the device.
- One final note, although the IP Search is able to find and configure any network device on the LAN except those that are behind a router, it is a good idea to set the host PC to the same subnet. In order to connect to the Web-based user interface of the network camera, the host PC must be in the same subnet. For more information about subnets, please consult your network administrator.

“Asoni IP Search” is a utility that provides an easier, more efficient way to configure the IP address and network settings of the network camera in Local Network (LAN).

The software can be installed from the attached software CD.

1. Once “Asoni IP Search” has been successfully installed on the computer, double click the “Search CAM4_CAM6_NVR6LX” icon on the desktop.

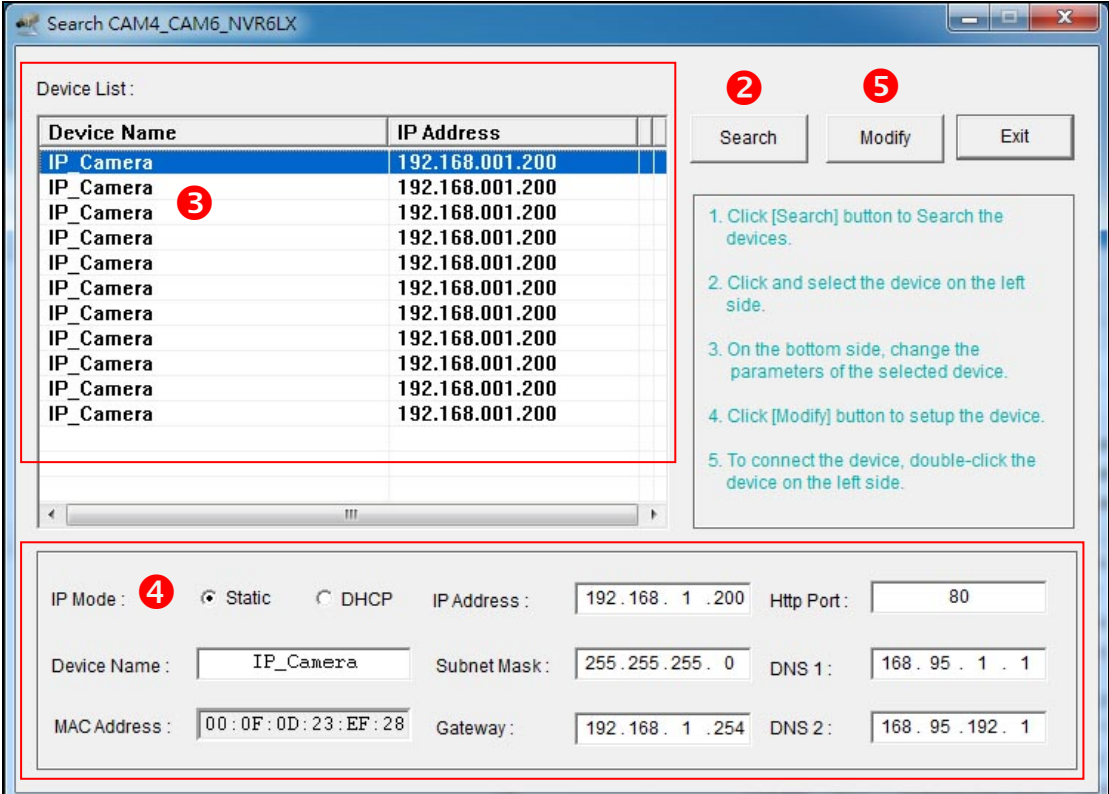

1. Click the desktop icon to launch the software.

2. Click the [Search] button to search for devices.

3. Select a device from the Device List.

4. Click the [Modify] button to configure the selected device.

5. Double-click the selected device in the Device List to connect.

Device Name	IP Address
IP_Camera	192.168.001.200
IP_Camera	192.168.001.200
IP_Camera	192.168.001.200
IP_Camera	192.168.001.200
IP_Camera	192.168.001.200
IP_Camera	192.168.001.200
IP_Camera	192.168.001.200
IP_Camera	192.168.001.200
IP_Camera	192.168.001.200
IP_Camera	192.168.001.200

IP Mode: Static DHCP IP Address: 192.168.1.200 Http Port: 80

Device Name: IP_Camera Subnet Mask: 255.255.255.0 DNS 1: 168.95.1.1

MAC Address: 00:0F:0D:23:EF:28 Gateway: 192.168.1.254 DNS 2: 168.95.192.1

2. IP Search searches all the network devices which connect to the intranet and lists on the window. Click **[Search]** button to search again.
3. From the list, click and select the device with the MAC Address that corresponds to the device that is to be configured.
4. The network configuration of the selected device will show on the bottom, filling in the Device Name, IP Address, Subnet Mask, Gateway and the others.
5. Click **[Modify]** button to save the settings into the device.
6. Wait for few seconds to let the device update the settings, and then click **[Search]** button again to re-search the network devices.
7. Double-click the network device listed on the window, It will open an IE browser and connect to this device directly.

4. Live Video

Start the IE browser, type the IP address of the network video server in the address field:

http://<IP of video server >

If the “HTTP Port” has been changed from “80”, type the URL as:

http://<IP of video server >:<HTTP Port>

After link to the video server, it will show a dialogue box. Key-in the user name and password to log-in and open the web page of video server.

The default user name and password are “**admin**” and “**admin**”.

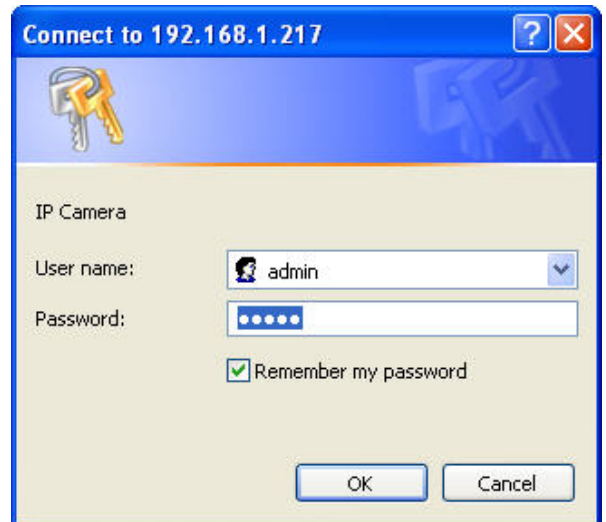

For the first time to view the video server’s video via IE, it will ask you to install the ActiveX component.



If the installation failed, please check the security setting for the IE browser.

1. In IE, click on **[Tools]** → **[Internet Options...]**
2. Click on **[Security]** Tab → **[Custom Level...]**
3. In Security Settings, under **[Download unsigned ActiveX controls]**, select “Enable” or “Prompt”.
4. In Security Settings, under **[Initialize and script ActiveX controls not marked as safe]**, select “Enable” or “Prompt”.
5. When pop-up window with warning message, click **[Yes]** to save the settings.

1

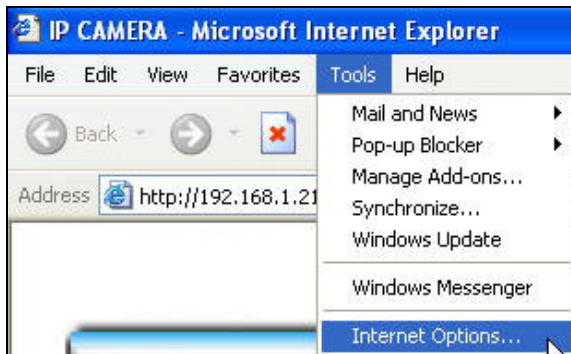

2

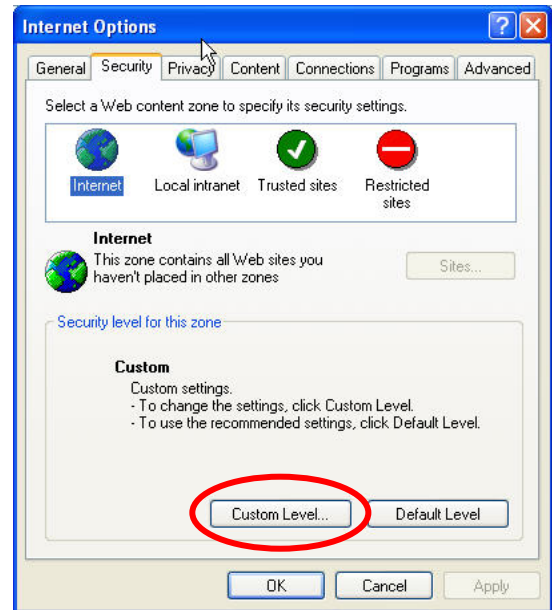

3

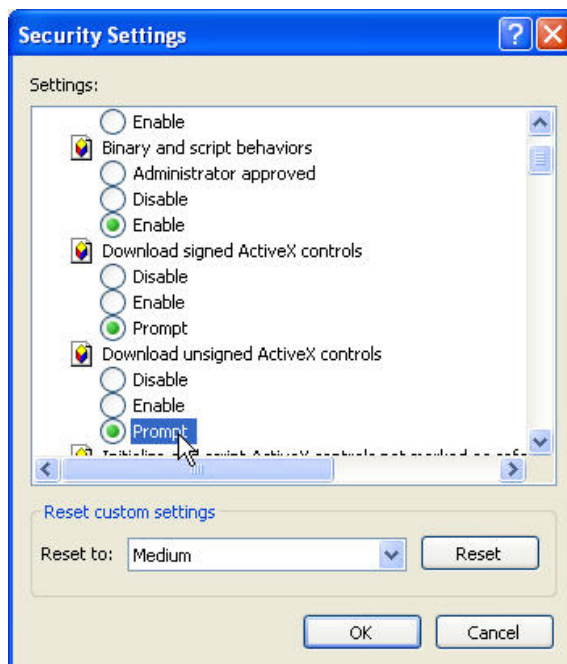

4

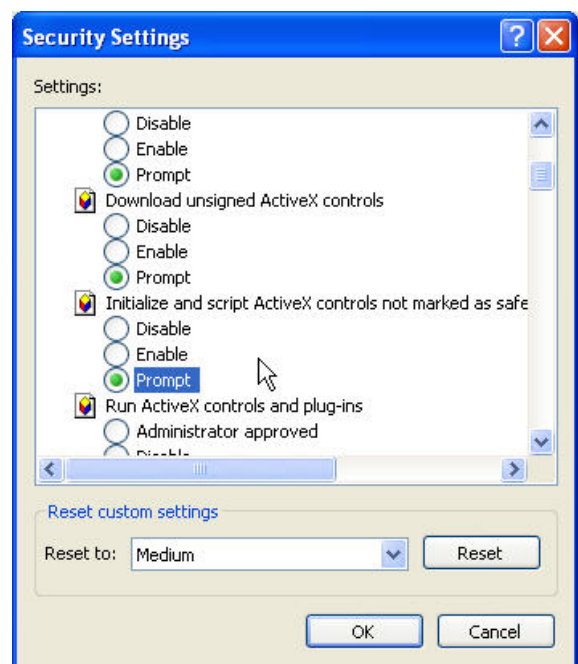

5

When popup the following dialogue box, click [Yes].

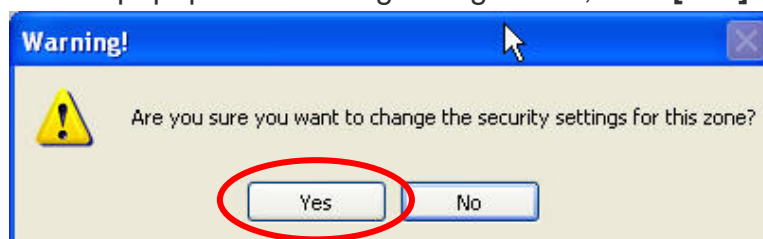





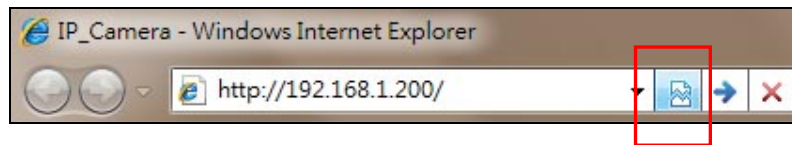



The web page of the device shows as following.

If you are using IE 8.0 or above, please click “Compatibility View” icon to make this web page works properly:



- ① **Streaming** : Select the streaming 1 or 2 from the pull-down list to display.
- ② **Language** : Change the display language temporarily.
 Note: The display language is changed temporarily for current connection, and it doesn't change the default language. To change the default language, please go to [Configuration](#) → [System Information](#) page.
- ③ **Configuration** : Go into the configuration page to set the parameters if necessary.
- ④ **Status Bar** : Shows system date/time, video resolution and video refresh rate (FPS).

- ⑤ **Online Visitor** : Shows how many users connect to this device.
- ⑥ **PTZ Model** : If a PTZ device is connected to the video server, click this button to setup the model, camera ID and baudrate of the PTZ device. Click this button again will hide the setup options.
- ⑥ **P/T/Z Control Panel** : If a PTZ device is connected to the video server, this control panel will be displayed automatically.

Pan/Tilt Control	Pan / Tilt the camera:	Click the direction buttons.
	Move camera back to the home position:	Click  button.
Speed	Adjust the speed of the camera movement:	Select the speed from the pull-down list, higher value is faster.
Zoom Focus Iris	Adjust the Zoom, Focus and Iris:	Click  or  button to adjust the camera.
Auto Pan	Automatic pan the camera from right to left and left to right:	Click  button beside "Auto Pan".
	Stop "Auto Pan":	Click  button beside "Auto Pan".
Patrol	Automatic move the camera to all preset points sequentially:	Click  button beside "Patrol".
	Stop "Patrol":	Click  button beside "Patrol".
Preset Point	Set / Change Preset Point:	Select the preset point from the pull-down list, move the camera to the position as your wish, input a name in the "Name" box, and then click  button.
	Go to Preset Point:	Select the preset point from the pull-down list and the camera will go to the position
	Remove Preset Point:	Select the preset point from the pull-down list and then click  button.

7 Function Buttons : Click these buttons will perform the following functions.



Full Screen : Click this button or double-click the video, the video will change to full screen mode.

Press **[Esc]** key or double-click the video again, it will back to normal mode.



Snapshot : Click this button to take snapshot of the video. The image will be

displayed in a pop-up window, click  to save as a jpg picture.



Record : Click this button to record the video into the local PC. It will ask you where to save the video. To stop recording, click this button again.

The saved video format is AVI. The recorded file can be played by Microsoft Media Player. **Note, H.264 decoder must be installed to play the recorded file. You can install "FFdshow" from the included CD for the decoder.**



Chatting : This device supports 2-way audio. Click this button, then you can use microphone which connected to the PC to talk to the video server side.



Voice : Click this button to turn on the audio from video server. Click again to turn off it.



Digital Zoom : Click this button, a pop-up window appears. You can enable / disable the digital zoom, and adjust the ratio.

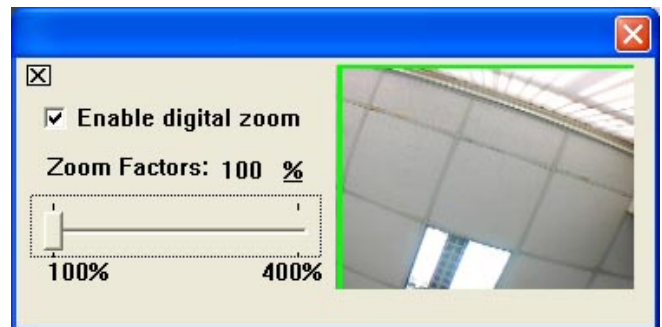

Relay Out (ON/OFF Switch) : Click the button to manually turn on / off the Relay via the built-in Digital Out.



Relay Out (Time Switch) : Click the button to manually turn on the Relay via the built-in Digital Out, after the interval time is passed, the Relay will be turned off automatically. The interval time can be set up in [Configuration](#) → [Event Handling](#) → [I/O](#).

5. Configuration

Click [**Configuration**] button to get into the configuration page. Click  [**Live View**] button to back to the Live-View page.

A. System

System Information

Set up the video server name, select language, and set up the video server time.



System Information

System Information				
Server Information				
MAC Address:	00:0F:0D:20:C8:09			
Server Name:	IP Camera	<input type="checkbox"/> Show on Status Bar		
LED Indicator:	<input checked="" type="radio"/> ON <input type="radio"/> OFF			
Default Language:	<input checked="" type="radio"/> English	<input type="radio"/> Traditional Chinese	<input type="radio"/> Simplified Chinese	
OSD Setting				
Time Stamp:	<input checked="" type="radio"/> Enable <input type="radio"/> Disable			
Position:	<input checked="" type="radio"/> Top-Left <input type="radio"/> Top-Right <input type="radio"/> Bottom-Left <input type="radio"/> Bottom-Right			
Text:	<input checked="" type="radio"/> Enable <input type="radio"/> Disable			
	OSD_Display Text Edit			
Time Setting				
Server Time:	2010/6/3 11:5:34 Time Zone: GMT+08:00			
Date Format:	<input checked="" type="radio"/> yy/mm/dd <input type="radio"/> mm/dd/yy <input type="radio"/> dd/mm/yy			
Time Zone:	GMT+08:00			
<input checked="" type="checkbox"/> Enable Daylight Saving:				
	Month	Week	Day of Week	Time
DST Start:	May	2nd	Monday	12 AM
DST End:	August	1st	Monday	12 AM
<input checked="" type="radio"/> Synchronize with NTP Server				
NTP Server:	198.123.30.132			
Update Schedule:	6 Hour			
Time Shift:	0 Minutes [-1440..1440]			
<input type="radio"/> Synchronize with PC's Time				
Date:	2010/6/3			
Time:	11:5:44			
<input type="radio"/> Manually Input Date and Time				
Date:	2010/6/3			
Time:	11:1:45			
<input type="radio"/> The date and time remain the same				
<input type="button" value="Apply"/>				

Server Information

Server Information			
MAC Address:	<input type="text" value="00:0F:0D:20:C8:09"/>		
Server Name:	<input type="text" value="IP Camera"/>	<input type="checkbox"/> Show on Status Bar	
LED Indicator:	<input checked="" type="radio"/> ON <input type="radio"/> OFF		
Default Language:	<input checked="" type="radio"/> English	<input type="radio"/> Traditional Chinese	<input type="radio"/> Simplified Chinese

MAC Address: The MAC address of the Ethernet network card in the device.

Server Name: You can type a name into this field to identify this device.

Show on Status Bar: Determine whether show the server name on the Status Bar.

LED Indicator: Determine whether light-on or turn-off the network and power status LEDs on the device.

Default Language: Select the default language for the user interface.

OSD Setting

OSD Setting	
Time Stamp:	<input checked="" type="radio"/> Enable <input type="radio"/> Disable
Position:	<input checked="" type="radio"/> Top-Left <input type="radio"/> Top-Right <input type="radio"/> Bottom-Left <input type="radio"/> Bottom-Right
Text:	<input checked="" type="radio"/> Enable <input type="radio"/> Disable
	<input type="text" value="OSD_Display"/> <input type="button" value="Text Edit"/>

Time Stamp: Enable this option will display the date and time on the video.

Position: Select the display position of Time stamp.

Text: Enable this option will display the OSD string on the video.

Text Edit: Click this button to open “Text Edit” dialog window. You can change the OSD string and adjust the size and alpha of the text. After editing, click **[Upgrade]** button.

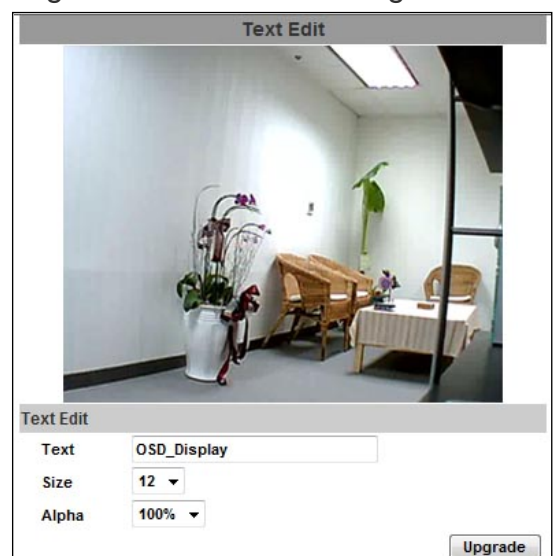

Time Setting

Time Setting				
Server Time:	2010/6/3 11:5:34 Time Zone: GMT+08:00			
Date Format:	<input checked="" type="radio"/> yy/mm/dd <input type="radio"/> mm/dd/yy <input type="radio"/> dd/mm/yy			
Time Zone:	GMT+08:00 ▼			
<input checked="" type="checkbox"/> Enable Daylight Saving:				
	Month	Week	Day of Week	Time
DST Start:	May ▼	2nd ▼	Monday ▼	12 AM ▼
DST End:	August ▼	1st ▼	Monday ▼	12 AM ▼
<input checked="" type="radio"/> Synchronize with NTP Server				
NTP Server:	198.123.30.132			
Update Schedule:	6 ▼ Hour			
Time Shift:	0 Minutes [-1440..1440]			
<input type="radio"/> Synchronize with PC's Time				
Date:	2010/6/3			
Time:	11:5:44			
<input type="radio"/> Manually Input Date and Time				
Date:	2010/6/3			
Time:	11:1:45			
<input type="radio"/> The date and time remain the same				

Date Format: Select the format to display the date.

Time Zone: Select the GMT to match your time zone.

Enable Daylight Saving: If using “Daylight Saving”, enable this option and select the start and end time.

Synchronize with NTP Server: Select this option and type the IP address of a NTP (Network Time Protocol) server, this device will synchronize the time with the NTP server via network.

- NTP Server: Type the IP address or URL of the NTP server.
- Update Schedule: Select the interval for the update time. For example, if select “6 Hours”, this device will synchronize the date and time with the NTP server every 6 hours.

Synchronize with PC's time: Select this option will synchronize the device time with the PC's time.

Manually Input Date and Time: Manually input the date and time.

The date and time remain the same: Keep the current date and time without change.

*After set up, click **[Apply]** to save the settings.*

User Management

You can add, remove and manage the users in this page.

This device supports 4 user groups:

- Administrator: The administrator can view, operate and configure all functions and settings of this device.
- PTZ: The users in PTZ group can view and operate all functions in Live-View page.
- Guest: The users in Guest group can only view the live video in Live-View page.
- Anonymous: The anonymous user can only view the live video in Live-View page. The privilege is same as Guest group.



User Management

User Management

Anonymous User Login

Yes No

Add User

User Name:

Password:

Confirm Password:

User Group: PTZ Guest

User List

User Name	User Group	Modify	Remove
admin	Administrator	Edit	
guest	Guest	Edit	Remove
PTZuser	PTZ	Edit	Remove

Anonymous User Login

To allow user visit this device without login, select **[Yes]** and then click **[Setting]** to enable this function.

Add User

To add a new user, type the user name and password, select the User Group, and

then click **[Add/Set]** to save the user.

User List

This table lists the current users.

Edit: To change the username and password, click **[Edit]** and modify the administrator or user in the pop-up window.

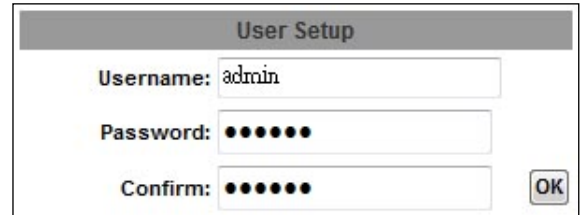

The image shows a 'User Setup' dialog box with three input fields and an 'OK' button. The 'Username' field contains the text 'admin'. The 'Password' and 'Confirm' fields are filled with seven black dots each. The 'OK' button is located to the right of the 'Confirm' field.

Remove: To remove the user, click **[Remove]**.

System Upgrade

This page allows user to upgrade firmware, restart device and restore the factory default settings.



System Upgrade

System Upgrade	
Firmware Upgrade	
Current Firmware Version:	V1.0.22_As.1
New Firmware:	<input type="text"/> <input type="button" value="Browse..."/>
<input type="button" value="Upgrade"/>	
Reboot System	
<input type="button" value="Reboot"/>	
Factory Default	
<input type="button" value="Default"/>	

Firmware Upgrade

The firmware can be upgraded online.

To update the firmware, click **[Browse...]** to select the new firmware file, and then click **[Upgrade]** to the procedure.

Reboot System

To restart the device, click **[Reboot]** and then click **[Yes]** on the prompted window.

Factory Default

To load the factory defaults, click **[Default]** and then click **[Yes]** on the prompted window. Note, all settings including User account, Network, A/V and Event settings will be restored to the factory defaults.

System Logs



System Logs

System Logs	
System Status Logs:	View
Motion Trigger Logs:	View
Digital-In Trigger Logs:	View
All Logs:	View

System Status Logs

Click the **[View]** button on the right side to list the logs of system status.

Motion Trigger Logs

Click the **[View]** button on the right side to list the logs of motion detection.

Digital-In Trigger Logs

Click the **[View]** button on the right side to list the logs of digital input detection.

All Logs

Click the **[View]** button on the right side to list all logs.

B. Video/Audio Setting

Video Format

This device supports H.264/MJPEG and MPEG4 (only for 3GPP streaming) Triple Mode and Triple Streaming, set the video parameters in this page.



Video Format

Video Format	
Streaming 1 Output Setting	
<input type="radio"/> Basic Mode <input checked="" type="radio"/> Advanced Mode	
Resolution:	D1 - 720x480
Bitrate Control Mode:	<input checked="" type="radio"/> CBR (Constant Bit Rate) <input type="radio"/> VBR (Variable Bit Rate)
CBR - Highest Video Bitrate:	1.5Mbps
VBR - Video Quantitative:	7
Frame Rate Per Second:	30 FPS
GOP Size:	1 X FPS GOP = 30
Video Compression Format:	H.264
RTSP Path:	<input type="text"/> *Audio Format= G.711 *Link the camera with this address -> rtsp://[IP]/
Streaming 2 Output Setting	
<input type="radio"/> Basic Mode <input checked="" type="radio"/> Advanced Mode	
Resolution:	D1 - 720x480
Quality:	High
Frame Rate Per Second:	30 FPS
Video Compression Format:	JPEG
RTSP Path:	<input type="text" value="v2"/> *Audio Format= G.711 *Link the camera with this address -> rtsp://[IP]/v2
3GPP Streaming Output Setting (Resolution=176x144, FPS=5, Video=MPEG4, Audio=AMR)	
<input checked="" type="radio"/> Enable <input type="radio"/> Disable	
3GPP Path:	<input type="text" value="3g"/> *Link the camera with this address -> rtsp://[IP]/3g *Link the camera (no audio) with this address -> rtsp://[IP]/3gx
<input type="button" value="Apply"/>	

Streaming 1 and 2 Output Setting

Basic / Advanced Mode: Select the mode to configure the parameters. Advanced mode provides more detail parameters for setting.

Resolution: Select the resolution from the pull-down list.

Frame Rate Per Second: The video refreshing rate per second. Select the frame rate from the pull-down list.

Video Compression Format: Choose H.264 or JPEG format to compress and output the video stream.

H.264: The video stream will be compressed in H.264 format. Choose CBR (Constant Bit Rate) or VBR (Variable Bit Rate) in Bitrate Control Mode.

- CBR: Set the Video Bitrate from 32Kbps ~ 4Mbps depend on the upload bandwidth of network. **The data size of video stream will be limited under the selected bit rate.**
- VBR: Set the Video Quantitative from 1 ~ 10, the higher value will get better video quality. **The data size of video stream is no limitation, if the upload bandwidth of network is lower than the data size, the video will be displayed slowly.**
- GOP Size: Set the GOP (Group of Picture) size. **If you don't know what value should be set, please set it to "1XFPS".**

JPEG: The video stream will be compressed in MJPEG format.

- Quality: 5 levels for select. The higher quality will get bigger file size.

RTSP Path: Assign a name to identify this video stream. When view the video stream with RTSP connection, the URL should be "rtsp://<Public IP of this device>:<RTSP port>/<RTSP path>".

3GPP Streaming Output Setting

3GPP Streaming Output Setting (Resolution=176x144, FPS=5, Video=MPEG4, Audio=AMR)	
<input checked="" type="radio"/> Enable <input type="radio"/> Disable	
3GPP Path:	<input type="text" value="3g"/> <p>*Link the camera with this address -> rtsp://[IP]/3g *Link the camera (no audio) with this address -> rtsp://[IP]/3gx</p>

After enable the 3GPP streaming, it will enable this device to send out the video in 3GPP format, and you can view the live video on the 3G mobile phone.

Since the bandwidth of 3G is not fast usually, the 3GPP streaming will be set to the following configuration:

- Resolution – Fixed to 176x144.
- Frame Rate –Fixed to 5FPS.
- Video Format – Fixed to MPEG4.
- Audio Format – Fixed to AMR.

3GPP Path: Assign a name to identify the 3GPP video stream

To view the live video with a 3G mobile phone or PDA, open “Streaming Player” or web browser in the mobile phone, type the URL as following to link and view the live video:

rtsp://<Public IP of video server>:<RTSP port>/<3GPP path>

* <Public IP of video server>: The public IP address of the video server.

* <RTSP port>: The RTSP port of the video server. This port is assigned in [Configuration → Network Setting → Network Setting](#)

* <3GPP path>: The name of the 3GPP video stream.

If your 3G mobile phone or PDA does not support the viewing of RTSP streaming, you can view the video server with http connection. To do this, use a Java compliant browser such as Opera, and type the URL as following to link and view the live video:

http://<Public IP of video server>:<HTTP port>/Jview.html

* <Public IP of video server>: The public IP address of the video server.

* <HTTP port>: The HTTP port of the video server. This port is assigned in [Configuration → Network Setting → Network Setting](#)

Note: Do not use the IE browser in 3G mobile phone because it doesn't support Java.

*After set up, click **[Apply]** to save the settings.*

Image Setting



Image Setting

Image Setting



Privacy Mask

Set Area: Draw/Clear Area 1 Draw/Clear Area 2 Draw/Clear Area 3 Save Area Settings

Image Quality

Brightness:	0 ▼
Contrast:	0 ▼
Hue:	0 ▼
Saturation:	0 ▼
Sharpness:	0 ▼

Default

Privacy Mask

For the security purpose, there are 3 areas can be setup for privacy masks, the masked areas will not be shown in Live-View and recorded file. To set up or clear the privacy mask, click **[Draw/Clear Area]** button, and then use mouse to drag the area on the video. After the configuration, click **[Save Area Settings]** button to save the settings.

Image Quality

Brightness / Contrast / Hue / Saturation / Sharpness: You can adjust these parameters to get clear video.

Default: Click **[Default]** button will load the default settings.

Audio Setting

This device supports 2-way audio. **Note, the audio will not be smooth when enable SD card recording function simultaneously.**

Audio from Device to Local PC

For this device to local PC, select **[Enable]** and then click **[Apply]** to start this function. If set to **[Disable]**, the **[Voice]** icon on Live View page is not workable.



Audio Setting



Audio from Local PC to This Device

For local PC to this device, click **[Chatting]** icon on the Live View page.



C. Network Setting

Network Setting



Network Setting

Network Setting		
IP Assignment		
<input type="radio"/> DHCP <input checked="" type="radio"/> Static IP		
IP Address:	192.168.11.77	
Subnet Mask:	255.255.255.0	
Gateway:	192.168.11.1	
DNS 1:	168.95.1.1	
DNS 2:	168.95.192.1	
Port Assignment		
HTTP Port:	80	
UPnP Setting		
UPnP:	<input checked="" type="radio"/> Enable <input type="radio"/> Disable	
UPnP Port Forwarding:	<input checked="" type="radio"/> Enable <input type="radio"/> Disable	
External HTTP Port:	8081	
External RTSP Port:	555	
RTSP Server Setting		
RTSP Server:	<input checked="" type="radio"/> Enable <input type="radio"/> Disable	
RTSP Port:	554	
RTP Start Port:	5000	[1024..9997]
RTP End Port:	9000	[1027..10000]
Multicast Setting (Based on the RTSP Server)		
Streaming 1:		
IP Address:	234.5.6.78	[224.3.1.0 ~ 239.255.255.255]
Port:	6000	[1 ~ 65535]
TTL:	15	[1 ~ 255]
Streaming 2:		
IP Address:	234.5.6.79	[224.3.1.0 ~ 239.255.255.255]
Port:	6001	[1 ~ 65535]
TTL:	15	[1 ~ 255]

IP Assignment

DHCP: If this device behinds a router and the router provides DHCP service, using DHCP, this device will get all network parameters from the router automatically.

Static: Assign IP address, subnet mask, gateway, and DNS manually.

Port Assignment

Set the port if necessary. If this device will be connected via Internet, configure the NAT (Network Address Translation) in router to match the port assignment.

HTTP Port: Set the port for HTTP connection. The default is “80”, change the port if you want to use router’s NAT (Network Address Translation) to make this device can be linked from Internet.

UPnP Setting

UPnP: Enable or disable the UPnP protocol.

This device supports UPnP, if the UPnP service is enabled on your computer, the device will automatically be detected and a new icon will be added to “My Network Places”.

Note: UPnP service must be enabled on your computer.

The Windows Vista and Windows 7 have enabled UPnP service by default. To activate UPnP service in Windows XP, please follow the procedure:

1. Open the “Control Panel” from the “Start” menu.
2. Select “Add/Remove Programs”.
3. Select “Add/Remove Windows Components” and open “Networking Services” section.
4. Click “Details” and select “UPnP” to setup the service.
5. The network device icon will be added to “My Network Places”.
6. You may double-click the network device icon to access it via IE browser.

UPnP Port Forwarding: Enable or disable the “UPnP Port Forwarding” function.

The “UPnP Port Forwarding” function provides an easy way to configure the NAT (Network Address Translation) in router. If the router equips “UPnP Port Forwarding” function too, this device will ask the router to open the “External HTTP Port” and “External RTSP Port” for this device automatically. Therefore, you don’t need to configure the Port Forwarding manually.

Note: Not all routers equip “UPnP Port Forwarding” function. The device will report whether this function is successful after click **[Apply]** button.

RTSP Server Setting

RTSP Server: The video stream can be direct retrieve via RTSP connection, you can close this function by disable this option.

RTSP Port: Set the port for transfer the video and audio. The default is “554”, change the port if you want to use router’s NAT (Network Address Translation) to make this device can be linked from Internet.

RTP Port: Set the port range of RTP port.

In RTSP mode, you may use TCP and UDP for connecting. TCP connection uses RTSP Port. UDP connection uses RTP Start and End Port.

Multicast Setting (Based on the RTSP Server)

Multicast addressing is a network technology for the delivery of streaming to a group of destinations simultaneously using the most efficient strategy to deliver the messages over each link of the network only once, creating copies only when the links to the multiple destinations split. To implement the Multicast, a switch or router that supports Multicast function is necessary in the network.

If your network supports Multicast, you can configure the device to enable this function by setup the following:

IP Address: This is the multicast group address the streaming should be sent to. You should configure each recipient with the same multicast group address and receive the streaming from this address. The range is 224.3.1.0 ~ 239.255.255.255

Port: The multicast port. The range is 1 ~ 65535

TTL: Time-To-Live (TTL) for Multicast Packets. This value decides how "far" from a sending host a given multicast packet should be forwarded.

Onvif Setting

This device supports Onvif standard, you can configure the following settings to compatible with the NVC (Network Video Client) such as NVR or recording software:

Onvif Setting	
Onvif Version:	<input type="radio"/> V1.02 <input checked="" type="radio"/> V1.01 <input type="radio"/> Disable
Security:	<input type="radio"/> Enable <input checked="" type="radio"/> Disable
RTSP Keepalive:	<input checked="" type="radio"/> Enable <input type="radio"/> Disable

Onvif Version: Select the version of Onvif standard, or disable the Onvif output.

Security: Enable or disable the Onvif security authentication.

RTSP Keepalive: If select “Enable”, when the NVC doesn’t send the command for

keeping the RTSP connection, this device will terminate the RTSP connection. If select “Disable”, this device will always keep the RTSP connection. If the “Time-out” error happens on NVC side, please disable this function.

*After set up, click **[Apply]** to save the settings.*

Wireless Setting

The Wireless model supports Wireless network connection, set the parameters in this page.

Note: Wireless network and Ethernet network use the same IP, user has to unplug Ethernet cable to activate the Wireless connection. If Ethernet cable is plugged, Wireless connection will be stopped.



Wireless

Wireless Setting			
Found Wireless Networks			
SSID	Mode	Security	Signal Strength
default	Infrastructure	OFF	45
Wireless Setting			
MAC Address:	00:08:A1:A3:AD:E8		
Mode:	Infrastructure ▼		
Operation Mode:	Auto ▼		
SSID:	default		
Security:	None ▼		
Apply			

Found Wireless Networks

The Wireless model will automatic search the available Wireless network and list in the SSID table. Please refer to the table to set the Wireless settings.

Wireless Setting

Mode: Select the mode of the connection from the pull-down list. “Infrastructure” is for connecting with the router. “Ad-hoc” is for connecting with PC directly.

Operation Mode: Select the mode from the pull-down list.

SSID: Choose a Wireless network from the SSID table, and type the SSID in the box. The SSID is case-sensitive.

Security: Select the security mode to match the Wireless network. It supports “None”, “WEP”, “WPA-PSK”, “WPA2-PSK” security encryption based on the setting of Router.

Ad-hoc

Ad-hoc is for connecting with PC directly. There is “Channel” to selected only when uses Ad-hoc mode. For example, if PC’s channel is 6, the “Channel” has to be 6 too.

Wireless Setting			
Found Wireless Networks			
SSID	Mode	Security	Signal Strength
default	Ad-hoc	OFF	45
Wireless Setting			
MAC Address:	00:08:A1:A3:AD:E8		
Mode:	Ad-hoc ▼		
Operation Mode:	Auto ▼		
SSID:	default		
Channel:	6 ▼		
Security:	None ▼		
<input type="button" value="Apply"/>			

WEP Setting

The Wireless model supports “WEP” security encryption. The settings must be same as the Router’s setting. Consult your network administrator to set the parameters.

Wireless Setting	
Found Wireless Networks	
SSID	Mode
default	Infrastructure
Security	Signal Strength
WEP	45
Wireless Setting	
MAC Address:	00:08:A1:A3:AD:E8
Mode:	Infrastructure ▼
Operation Mode:	Auto ▼
SSID:	default
Security:	WEP ▼
WEP Setting	
Authentication:	Open System ▼
Encryption:	128 bit ▼
Key Type:	ASCII ▼ (13 characters max)
Key 1:	<input checked="" type="radio"/> 1234567890123
Key 2:	<input type="radio"/> <input type="text"/>
Key 3:	<input type="radio"/> <input type="text"/>
Key 4:	<input type="radio"/> <input type="text"/>
<input type="button" value="Apply"/>	

Authentication: There are “Open System” and “Shared Keys”, it is based on different encryptions. This has to be the same as the Router’s setting.

Encryption: There are 64 bits and 128 bits. This is based on Key Type based on the Router’s setting.

Key Type: There are HEX and ASCII. When selecting HEX, the user only can input 0~9 characters and use A, B, C, D, E, and F. When selecting ASCII, the user can input any character (case [upper cases/ lower cases] sensitive).

Key 1~4: Based on Key Type to input characters.

WPA-PSK Setting

The Wireless model supports “WPA-PSK” and “WPA2-PSK” security encryption. The settings must be same as the Router’s setting. Consult your network administrator to set the parameters.

Wireless Setting			
Found Wireless Networks			
SSID	Mode	Security	Signal Strength
default	Infrastructure	WPA-PSK	45
Wireless Setting			
MAC Address:	00:08:A1:A3:AD:E8		
Mode:	Infrastructure ▼		
Operation Mode:	Auto ▼		
SSID:	default		
Security:	WPA-PSK ▼		
WPA-PSK Setting			
Encryption:	TKIP ▼		
Pre-Shared Key:	1234567890	(ASCII format, 8~63 characters)	
<input type="button" value="Apply"/>			

Encryption: There are “TKIP” and “AES”.

Pre-Shared Key: Allow any characters (case [upper cases/ lower cases] sensitive).

After set up, click **[Apply]** to save the settings.

Mail / FTP / Samba Setting

To send out the event video to E-mail, FTP or Samba network storage, please set up the configuration first.



Mail / FTP/ Samba

Mail & FTP	
Mail Setting	
Login Method:	Account ▾
Send Mail Server:	smtp.mailserver.com
User Name:	test
Password:	••••
Sender's Mail:	sender@mailserver.com
Receiver's Mail:	receiver@abcmail.com
Bcc Mail:	boss@abcmail.com
Mail Port:	25 (Default Port = 25)
<input type="button" value="Test"/>	
FTP Setting	
FTP Server:	ftp.company.com
User Name:	ftptest
Password:	••••
FTP Port:	21 (Default Port = 21)
Store Path:	/
FTP Mode:	PORT ▾
Auto Create Folder by Date:	Yes ▾ (ex:Path/20100115/121032m.avi)
<input type="button" value="Test"/>	
Samba (Network Storage) Setting	
NAS Location:	\\192.168.11.50\Event (ex: \\NAS IP_Address\Folder)
Workgroup:	WORKGROUP
User Name:	sambatest
Password:	••••
Auto Create Folder by Date:	Yes ▾ (ex: NAS_Location/20100115/121032m.avi)
<input type="button" value="Test"/>	
<input type="button" value="Apply"/>	

Mail Setting

Mail Setting	
Login Method:	Account ▼
Send Mail Server:	smtp.mailserver.com
User Name:	test
Password:	••••
Sender's Mail:	sender@mailserver.com
Receiver's Mail:	receiver@abcmail.com
Bcc Mail:	boss@abcmail.com
Mail Port:	25 (Default Port = 25)
<input type="button" value="Test"/>	

Login Method: This device provides 2 kinds of mail settings. “Anonymous” for the mail server which doesn’t need login with user name and password. “Account” for the mail server which needs login with user name and password.

Send Mail Server: The IP address or URL of the send-mail server.

User Name / Password: The user name and password of the sender to login mail server and send the mail.

Sender’s Mail: The sender’s mail address.

Receiver’s Mail: The receiver’s mail address.

BCC Mail: The mail address to receive the mail also.

Mail Port: The port of the mail service. Default is 25.

FTP Setting

FTP Setting	
FTP Server:	ftp.company.com
User Name:	ftptest
Password:	••••
FTP Port:	21 (Default Port = 21)
Store Path:	/
FTP Mode:	PORT ▼
Create the Folder:	Yes ▼ (ex:Path/20100115/121032m.avi)
<input type="button" value="Test"/>	

FTP Server: The IP address or URL of the FTP server.

User Name / Password: The user name and password to log in the FTP server.

FTP Port: The port of the FTP service. Default is 21.

Store Path: The path to save the sent video file.

FTP Mode: Select “PORT” or “PASV” to fit the FTP server. “PORT” is for sending file to an Active FTP server; “PASV” is for sending file to a Passive FTP server.

Auto Create Folder by Date: If select “Yes”, a folder will be created under the “Store Path” and named with the date, and then the video file will be saved in this folder. If select “No”, the video file will be saved in the “Store Path” without folder.

Samba (Network Storage) Setting

“Samba” is a networking protocol provides file sharing service between network devices. If you have a network storage is running Samba service, this video server can send the event video or snapshot to the network storage directly.

Samba (Network Storage) Setting	
NAS Location:	<input type="text" value="\\192.168.11.50\Event"/> (ex: \\NAS IP_Address\Folder)
Workgroup:	<input type="text" value="WORKGROUP"/>
User Name:	<input type="text" value="sambatest"/>
Password:	<input type="password" value="••••"/>
Auto Create Folder by Date:	Yes <input type="checkbox"/> (ex: NAS_Location/20100115/121032m.avi)
<input type="button" value="Test"/>	

NAS Location: The location of the Samba network storage, including IP address or URL and the folder, the event video or snapshot will be send to this location.

Workgroup: Type the work group this Samba network storage belong to.

User Name / Password: The user name and password to log in the Samba network storage.

Auto Create Folder by Date: If select “Yes”, a folder will be created under the “NAS Location” and named with the date, and then the video file will be saved in this folder. If select “No”, the video file will be saved in the “NAS Location” without folder.

*After set up, click **[Apply]** to save the settings.*

Test the Settings

You can click **[Test]** button, this device will send a test mail to receiver’s mail box, or upload a test file to FTP site and the Samba network storage, to make sure the settings of mail, FTP or Samba network storage are correct.

PPPoE Setting

If this device connects to an ADSL modem directly and want to use PPPoE connection, set the parameters in this page.



PPPoE Setting

PPPoE Setting	
PPPoE Connection:	<input checked="" type="radio"/> Enable <input type="radio"/> Disable
User Name:	<input type="text" value="adsluser"/>
Password:	<input type="password" value="••••"/>
Send E-mail after Dialed:	<input checked="" type="checkbox"/> Enable
E-mail Subject:	<input type="text" value="PPPoE From IP Camera"/>
<input type="button" value="Apply"/>	

PPPoE Connection

Select **[Enable]** to use PPPoE. Type in user name and password for the ADSL connection.

Send E-mail After Dialed

If select **[Enable]**, when connect to the Internet via PPPoE, this device will send a mail with the Subject to a specific mail account, this mail contains the public IP address of the ADSL connection.

To set the mail account, please refer to [Configuration → Network Setting → Mail&FTP](#) page.

E-mail Subject

The subject of the E-mail will be sent.

*After set up, click **[Apply]** to save the settings.*

DDNS Setting

This device supports DDNS, set the parameters in this page.



DDNS Setting

Dynamic DNS Setting	
DDNS Setting	
<input checked="" type="radio"/> Enable <input type="radio"/> Disable	
Provider:	dyndns.org ▼
Host Name:	test.dyndns.org
User Name:	test
Password:	••••
Schedule Update:	1440 Minutes
Status	
http://test.dyndns.org	
<input type="button" value="Apply"/>	
Note: <ol style="list-style-type: none"> Schedule Update: Depends on the input time of Schedule Update, it will update DDNS's web site automatically. The time range is from 5 to 5000 minutes. *0: It will not update. dyndns.org & 3322.org: Update once per day is recommended (1440 minutes per day). If updated too frequently, it will be blocked. 	

DDNS Setting

There are several DDNS providers can be selected. Select the provider from the pull-down list, input Hostname, User name, Password and the Schedule Update time, and then click **[Apply]** to connect to the DDNS provider.

Status

This field will display the message to indicate the status of DDNS service.

Updating: Information update.

Idle: Stop service.

http://<hostname (username)>.<provider>.com: DDNS registration successful, can now link to the device with this URL address.

Update Failed, the name is already registered: The hostname or username has already been used. Please change it.

Update Failed, check your internet connection: Network connection failed.

Update Failed, please check the account information with you provider: The input hostname, username or password may be wrong.

D. Event Handling

Event Setting

This device supports multiple event settings.



Event

Event Setting

Motion Detection

Set Area:	Draw/Clear Area1	Draw/Clear Area2	Draw/Clear Area3
Sensitivity:	5	5	5
<input checked="" type="checkbox"/> Detect Area 1:	<input checked="" type="checkbox"/> E-mail	<input type="checkbox"/> FTP	<input checked="" type="checkbox"/> Out1 <input type="checkbox"/> Out2 <input type="checkbox"/> Save to SD card <input type="checkbox"/> Save to Samba
<input checked="" type="checkbox"/> Detect Area 2:	<input type="checkbox"/> E-mail	<input checked="" type="checkbox"/> FTP	<input type="checkbox"/> Out1 <input checked="" type="checkbox"/> Out2 <input type="checkbox"/> Save to SD card <input type="checkbox"/> Save to Samba
<input checked="" type="checkbox"/> Detect Area 3:	<input type="checkbox"/> E-mail	<input type="checkbox"/> FTP	<input type="checkbox"/> Out1 <input type="checkbox"/> Out2 <input checked="" type="checkbox"/> Save to SD card <input type="checkbox"/> Save to Samba
Log :	<input type="checkbox"/> E-mail <input type="checkbox"/> FTP <input type="checkbox"/> Save to Samba		
E-Mail Subject:	Server Warning!		
Detection Interval:	10 sec <small>a period of time between every two motions detected.</small>		
<input type="checkbox"/> Enable motion detection based on - Schedule Time			

Record File Setting

Record Format: Video(Record time = [PreAlarm] ~ [PostAlarm])

Pre and Post Record Time Setting

Pre Alarm: 5 sec Post Alarm: 5 sec

Network Disconnection Detect

When Dis-connected: Record Video into SD Card

Specific IP Detection

Detect IP: Enable Disable

IP Address: www.google.com

Detection Interval: 30 sec

When Dis-connected: Record Video into SD Card

This device supports 4 kinds of event detections:

- Motion Detection.
- Digital Input Detection.
- Network Disconnection Detection: This event will be triggered once the wire network is disconnected.
- Specific IP Detection: This event will be triggered once the network connection with a specific IP address is disconnected.

Motion Detection

This device allows 3 areas for detect motion. When motion detection is triggered, it can send the video or snapshot to specific mail address; transmit the video or snapshot to remote FTP server or Samba network storage; trigger the digital out; record video or snapshot into local SD card.

Event Setting



Motion Detection

Set Area:	Draw/Clear Area1	Draw/Clear Area2	Draw/Clear Area3
Sensitivity:	5	5	5
<input checked="" type="checkbox"/> Detect Area 1:	<input checked="" type="checkbox"/> E-mail	<input type="checkbox"/> FTP	<input checked="" type="checkbox"/> Out1
<input checked="" type="checkbox"/> Detect Area 2:	<input type="checkbox"/> E-mail	<input checked="" type="checkbox"/> FTP	<input checked="" type="checkbox"/> Out2
<input checked="" type="checkbox"/> Detect Area 3:	<input type="checkbox"/> E-mail	<input type="checkbox"/> FTP	<input checked="" type="checkbox"/> Save to SD card
Log :	<input type="checkbox"/> E-mail <input type="checkbox"/> FTP <input type="checkbox"/> Save to Samba		
E-Mail Subject:	Server Warning!		
Detection Interval:	10 sec <small>a period of time between every two motions detected.</small>		
<input type="checkbox"/> Enable motion detection based on - Schedule Time			

Set the Area: To set up or clear the motion area, click **[Draw/Clear Area]** button on

“Set Area” row, and then use mouse to drag the area on the video.

Adjust the Sensitivity: To adjust the sensitivity of detection, select the level from the pull-down list.

Activate Motion Detection: To activate the motion detection, enable the [**Detect Area**] check box

Actions when Motion Detection is Trigger: Select what actions will be taken once the motion detection is triggered in each area.

- E-mail: When the motion detection is triggered in this area, send the recorded video or snapshot to the specific mail address.
- FTP: When the motion detection is triggered in this area, send the recorded video or snapshot to the specific FTP site.
- Save to Samba: When the motion detection is triggered in this area, send the recorded video or snapshot to the Samba network storage.

To set the mail account FTP site and Samba network storage, please refer to [Configuration → Network Setting → Mail&FTP](#) page.

- Out1 / Out2: When the motion detection is triggered in this area, turn on the Digital Output 1 or Digital Output 2.
- Save to SD Card: When the motion detection is triggered in this area, record the video or snapshot into the local SD card.

Log: If “Save to SD Card” option has been selected for action, you can determine whether send a message to the specific mail address FTP site or Samba network storage.

E-Mail Subject: The subject of the E-mail will be sent.

Detection Interval: This option provides two functions:

- The interval time between multiple detections. For example, if the time set to 10 seconds, when the motion detection is triggered at time 10H:05M:10S, the next detection will be accepted after 10H:05M:20S. The detections between 10H:05M:10S to 10H:05M:19S will not be accepted.
- If the “Out” is selected for the action, the Interval means “Digital Output On” period. For example, if Interval set to 20 seconds, when the motion detection is triggered, the Digital Output will be “On” and lasting for 20 seconds, and then “Off” automatically.

Enable Motion Detection in Schedule Time: Enable this option will automatic activate the motion detection with scheduled time and stop the detection in the other time. Please refer to [Schedule](#) page to setup the schedule time.

Recommendation of Motion Detection Area

To ensure the Motion Detection works well, and avoid unnecessary trigger, please follow the rules to draw the Motion Detection Areas:

- The moving object larger than the 50% of the Motion Detection Area, it will be detected, and the Motion Detection is triggered.
- The moving object smaller than the 50% of the Motion Detection Area, it will not be detected, and the Motion Detection will not be triggered.
- Recommend use 3 smaller Motion Detection Areas to replace a large area.

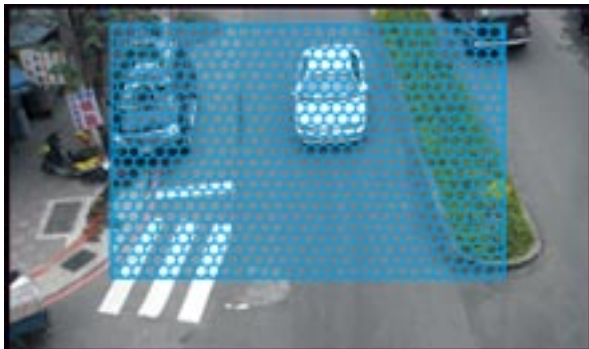

The moving object smaller than the 50% of the motion area, it will not be detected!

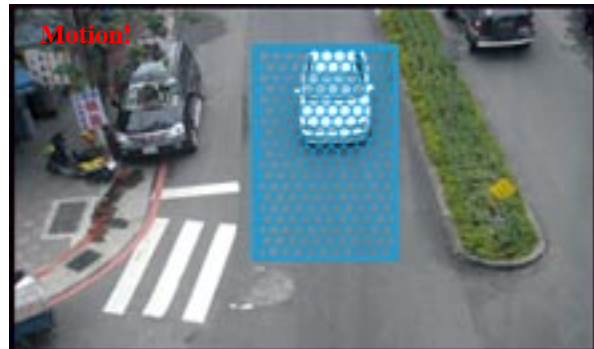

The moving object larger than the 50% of the motion area, it will be detected, and the motion is triggered!

To detect the smaller moving object, use 3 motion areas to replace a large motion area, refer the figure below:

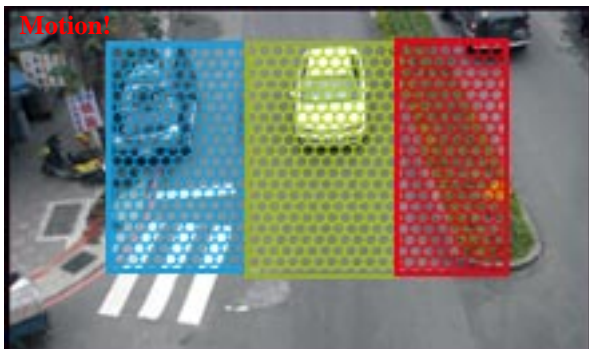

The moving object will be detected when it is in any of the 3 motion areas, and the motion is triggered!

Record File Setting

There are 3 methods to record the event video in SD card or send out via E-mail, FTP:

Record File Setting	
Record Format:	Video(Record time = [PreAlarm] ~ [PostAlarm])
Pre and Post Record Time Setting	
Pre Alarm:	5 sec
Post Alarm:	5 sec

Video: When an event (Motion Detection or Digital Input Detection) is triggered, the video will be recorded as still image with AVI format. The beginning and ending time of the file is depending on the Pre and Post Record Time Setting.

Snapshots: This option is available when the “Video Format” of streaming 1 is set as “JPEG” in Video Format. When an event (Motion Detection or Digital Input Detection) is triggered, this device will take a series of snapshot with JPG format. The beginning and ending time of the snapshot pictures is depending on the Pre and Post Record Time Setting.

Snapshot (Single): This option is available when the “Video Format” of streaming 1 is set as “JPEG” in Video Format page. When an event (Motion Detection or Digital Input Detection) is triggered, this device will take a snapshot with JPG format.

Pre and Post Record Time Setting

Configure the record time for the event recording file. For example, if set “Pre Alarm” as 3 seconds and set “Post Alarm” as 5 seconds, when an event (Motion Detection or Digital Input Detection) is triggered at time 10H:05M:10S, the video will be recorded from 10H:05M:07S to 10H:05M:14S.

Note: Limited by the built-in RAM of this device, when data is too much or video quality set too high, it will cause recording frame drop or decrease the recording time of post alarm.

To avoid the “frame drop” situation, please reduce the bitrate of the video. We recommend connect the device in LAN (Local Network) and set the video as CBR, and Bitrate less than 1.5Mbps.

Network Disconnection Detect

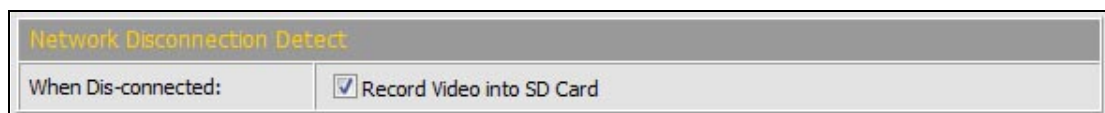

After enable the check box of “Record Video into SD Card”, when the wire network is disconnected, it will save the video into local SD card.

Note: When this event is happen, the frame rate of live video and recorded video will be limited to 5FPS. The longest continue record period of single video file is 20 minutes, and the interval of two video files is fixed with 1 minute.

Specific IP Detection

For the use of recording software, this device supports the detection of the connection of this device and PC. Whenever the connection is disconnected, it records the video to local SD card to make sure the video recording is continuous.

Specific IP Detection	
Detect IP:	<input checked="" type="radio"/> Enable <input type="radio"/> Disable
IP Address:	<input type="text" value="192.168.1.10"/>
Detection Interval:	<input type="text" value="30 sec"/> ▼
When Dis-connected:	<input checked="" type="checkbox"/> Record Video into SD Card

Detect IP – Enable / Disable: Select to enable or disable this function.

IP Address: The IP address or URL of the PC which installed the recording software.

Detection Interval: The interval time of the detection.

When Dis-connected: After enable the check box of “Record Video into SD Card”, when the network connection of PC is disconnected, it will save the video into local SD card.

Note: When this event is happen, the frame rate of live video and recorded video will be limited to 5FPS. The longest continue record period of single video file is 20 minutes, and the interval of two video files is fixed with 1 minute.

After set up, click **[Apply]** to save the settings.

I/O Setting

This device provides Digital Input and Digital Output. When the Digital Input is triggered, it can send the video or snapshot to specific mail address; transmit the video or snapshot to remote FTP server or Samba network storage; trigger the digital out; record video or snapshot into local SD card.



I/O Setting

I/O Setting	
Digital Input Setting	
Input 1 Sensor Type:	N.O ▾
Input 1 Trigger Action:	<input type="checkbox"/> E-mail <input checked="" type="checkbox"/> FTP <input checked="" type="checkbox"/> Out1 <input type="checkbox"/> Out2 <input checked="" type="checkbox"/> Save to SD <input type="checkbox"/> Save to Samba
Input 2 Sensor Type:	N.O ▾
Input 2 Trigger Action:	<input type="checkbox"/> E-mail <input checked="" type="checkbox"/> FTP <input type="checkbox"/> Out1 <input checked="" type="checkbox"/> Out2 <input checked="" type="checkbox"/> Save to SD <input type="checkbox"/> Save to Samba
Log:	<input type="checkbox"/> E-mail <input type="checkbox"/> FTP <input type="checkbox"/> Save to Samba
E-Mail Subject:	GPIO In Detected!
Detection Interval:	10 sec ▾
<input type="checkbox"/> Enable Digital Input detection based on - Schedule Time	
Digital Output Setting	
Output Switch Type:	<input type="radio"/> OnOff Switch <input checked="" type="radio"/> Time Switch
Turn-On Time:	10 sec ▾
<input type="button" value="Apply"/>	

Digital Input Setting

Input 1 / 2 Sensor Type: Select the type of the sensor which connected to the Digital Input. **[N.O]** means “Normally Opened”, this type of sensor will be triggered when it is closed. **[N.C]** means “Normally Closed”, this type of sensor will be triggered when it is opened.

Input 1 / 2 Trigger Action: Select the actions when the Digital Input is triggered.

- E-mail: When the Digital Input is triggered, send the recorded video or snapshot to the specific mail address.
- FTP: When the Digital Input is triggered, send the recorded video or snapshot to the specific FTP site.
- Save to Samba: When the Digital Input is triggered, send the recorded video or snapshot to the Samba network storage.

To set the mail account FTP site and Samba network storage, please refer to [Configuration → Network Setting → Mail&FTP](#) page.

- Out1 / 2: When the Digital Input is triggered, activate the Digital Output 1 or Digital Output 2.
- Save to SD Card: When the Digital Input is triggered, record the video or snapshot into to SD card.

Log: If “Save to SD Card” option has been selected for action, you can determine whether send a message to the specific mail address FTP site or Samba network storage.

E-Mail Subject: The subject of the E-mail will be sent.

Detection Interval: This option provides two functions.

- The interval time between multiple detections. For example, if the time set to 10 seconds, when the Digital Input is triggered at time 10H:05M:10S, the next trigger will be accepted after 10H:05M:20S. The triggers between 10H:05M:10S to 10H:05M:19S will not be accepted.
- If the “Out” is selected for the action, the Interval means “Digital Output On” period. For example, if Interval set to 20 seconds, when the Digital Input is triggered, the Digital Output will be “On” and lasting for 20 seconds, and then “Off” automatically.

Enable Digital Input Detection in Schedule Time: Enable this option will automatic activate the Digital-Input detection with scheduled time and stop the detection in the other time. Please refer to [Schedule](#) page to setup the schedule time.

Digital Output Setting

This section is for setup the parameters of Digital Output.

Note: The following settings are available when manually turn on the Relay Out on Live-View page.

Output Switch Type: Select the type of the Digital Output switch. **[On/Off Switch]** will be triggered to On or Off constantly. **[Time Switch]** will be triggered to “On” and lasting for a period time, and then “Off” automatically.

Turn-On Time: If the Digital Output switch is a “Time Switch”, the lasting time of the “On” period can be set here.

*After set up, click **[Apply]** to save the settings.*

Schedule

This function provides the schedule for the following:

- Send Snapshot with the Scheduled Time: automatic send a snapshot to the E-mail address, FTP server or Samba network storage, or save to SD card. The interval time can be set.
- Activate and Stop the Motion Detection with Scheduled Time: if the “Enable Motion Detection in Schedule Time” option in [Configuration → Event Handling → Event Setting → Motion Detection](#) page is enabled, the motion detection will be activated with scheduled time and stop the detection in the other time.
- Activate and Stop the Digital Input Detection with Scheduled Time: if the “Enable Digital Input Detection in Schedule Time” option in [Configuration → Event Handling → I/O Setting](#) page is enabled, the Digital-Input detection will be activated with scheduled time and stop the detection in the other time.



Schedule

Schedule

All	0	1	2	3	4	5	6	7	8	9	10	11	12	13	14	15	16	17	18	19	20	21	22	23
Mon.																								
Tue.																								
Wed.																								
Thu.																								
Fri.																								
Sat.																								
Sun.																								

Scheduled Hours

Send and Save Snapshot with Schedule Time

Enable Disable

Snapshot: E-mail FTP Save to SD card Save to Samba

Interval: Second(s) [1..50000]

File Name:

Setup Schedule

Select / Unselect All Time: Click [All] of the top-left of the time table to select or

unselect all time. The square in green means the time is selected; the square in light-grey means the time is unselected.

Select / Unselect Specific Time: Click the square of the time table to select or unselect the specific time. The square in green means the time is selected; the square in light-grey means the time is unselected.

Send Snapshot with Scheduled Time

Enable / Disable: To enable or disable the schedule function.

Snapshot: Select the method to send out the snapshot.

- E-mail: Automatic send the snapshot to the specific mail address, the interval time of the snapshot pictures is depending on the Interval setting.
- FTP: Automatic send the snapshot to the specific FTP site, the interval time of the snapshot pictures is depending on the Interval setting.
- Save to Samba: Automatic send the snapshot to the Samba network storage, the interval time of the snapshot pictures is depending on the Interval setting.
To set the mail account FTP site and Samba network storage, please refer to [Configuration → Network Setting → Mail&FTP](#) page.
- Save to SD Card: Automatic save the snapshot into SD card, the interval time of the snapshot pictures is depending on the Interval setting.

Interval: The interval time of the snapshot pictures. For example, if the time set to 10 seconds, in the scheduled time, the device will send out snapshot every 10 seconds.

File Name: The header of the filename of the snapshot. For example, if you input “Camera” in this field, the filename of the snapshot will be “Camera-yyyymmdd-hhmmss.jpg”, “yyyymmdd” indicates the year, month and date; hhmmss indicates the hour, minute and second.

*After set up, click **[Apply]** to save the settings.*

SD Card

In this page, if a SD Card is inserted, you can record the video once an event is triggered, play back and manage the recorded files in the SD Card.

Note: The SD card must be formatted as FAT or FAT32 file system.

The use of the SD Card will affect the operation of this device slightly, such as affecting the frame rate of the video.

Install SD Card

Make sure the direction and pushing SD card into the slot completely.

Record

Enable **[Save to SD Card]** option in [Event Setting](#) or [I/O Setting](#) page, the video can be recorded into the card once the event is triggered. When the SD Card is full, it will remove the earliest file automatically.

Playback

When open this page, the date of recorded files shows.



SD Card

Recorded Files in SD Card

20100603

SD Card: << 239M / 239M >>

Auto Deletion

Auto Deletion: (Keep 1/ 2/ 3/ 4...days)

2010/06/03

Time	Video	Event Type	<input type="checkbox"/>
11:39:32	113932m.avi	Motion Detection	<input type="checkbox"/>
11:39:42	113942m.avi	Motion Detection	<input type="checkbox"/>
11:39:52	113952m.avi	Motion Detection	<input type="checkbox"/>
11:40:02	114002m.avi	Motion Detection	<input type="checkbox"/>
11:40:12	114012m.avi	Motion Detection	<input type="checkbox"/>
11:40:22	114022m.avi	Motion Detection	<input type="checkbox"/>
11:40:32	114032m.avi	Motion Detection	<input type="checkbox"/>
11:40:42	114042m.avi	Motion Detection	<input type="checkbox"/>
11:40:52	114052m.avi	Motion Detection	<input type="checkbox"/>
11:41:02	114102m.avi	Motion Detection	<input type="checkbox"/>

1 2

[Files link daily.](#)

The “.avi” extension name of the file means this file is a video file; the “.jpg” extension name means it is a picture file. Click the file to start Microsoft Media Player to play it. If the bandwidth is lower for playback directly, please right-click on the file and select **[Save As...]** to download it to the PC, and then play the downloaded file with Microsoft Media Player.

Note: the video format is compressed with H.264, the PC must install the H.264 decoder. You can install “FFdshow” from the included CD for the decoder.

Delete Recorded File

To delete the recorded file, check the check box of the file, then click **[Del]** button.

Format SD Card

If you want to empty the SD card, click **[Format SD Card]** to format the card.

To view the recorded files, just click the date, it will show the list of the recorded files.

Auto Deletion

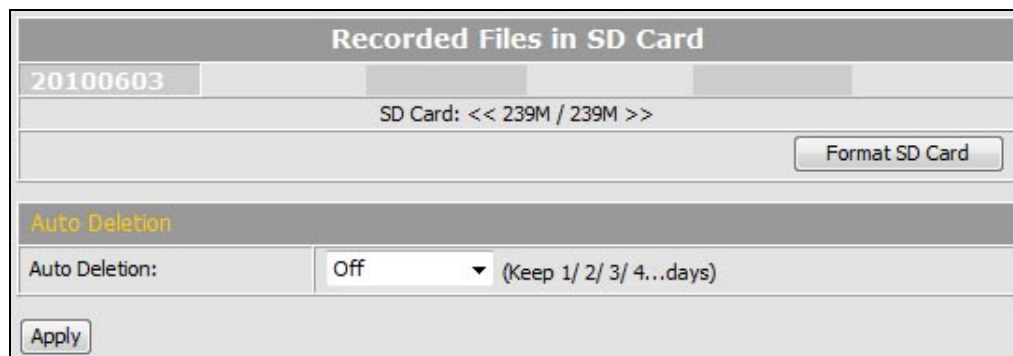

If enable this function, the recorded files before the selected day will be deleted automatically. After select the option, click **[Apply]** to save the setting.

6. Network Configuration

A. Intranet Only

Connects to PC Directly

If you want to connect the video server to PC directly for the very first time setup, please refer to the figure below for the connection.

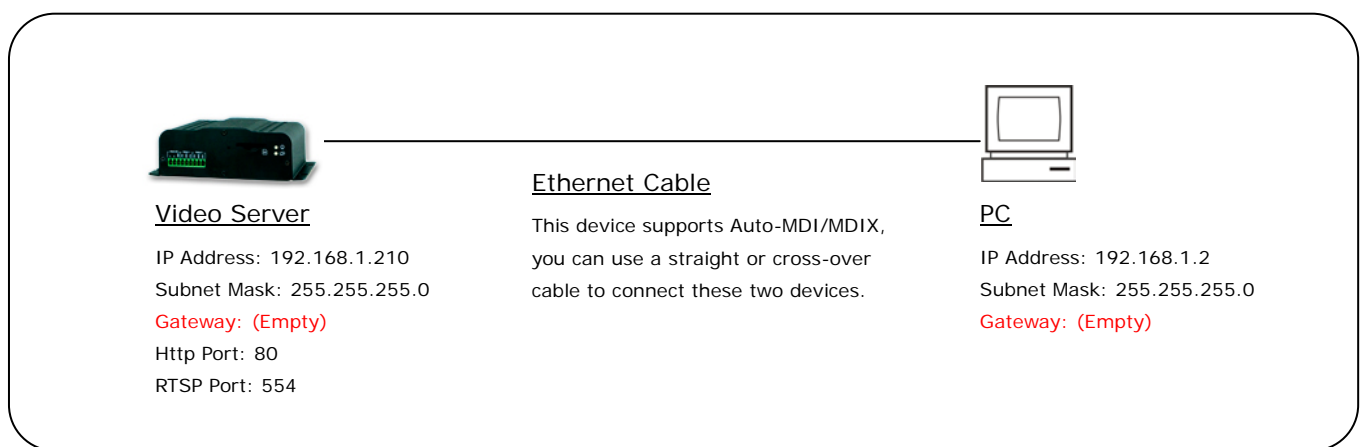

- Connect the video server to PC with Ethernet cable. The video server equips an Auto-MDI/MDIX network connector, you can use a straight or cross-over Ethernet cable.
- Refer to [Configuration → Network → Network](#) page to configure the IP settings.
- Please make sure the IP address of PC and video server are in the same subnet. Ex. [192.168.1.2](#) and [192.168.1.210](#) have the same subnet.
- Set Subnet Mask of PC and video server.
- Clear the Gateway of PC and video server to empty.

For example, if the IP settings have been configured as the above figure, the video server can be linked with following addresses:

Client	Video Server	Link Address	Remark
PC	Video Server	http://192.168.1.210	

Connects to an Exist LAN

If the video server will be used in a local network (LAN) and don't allow to access via Internet, please refer to the figure below for the connection.

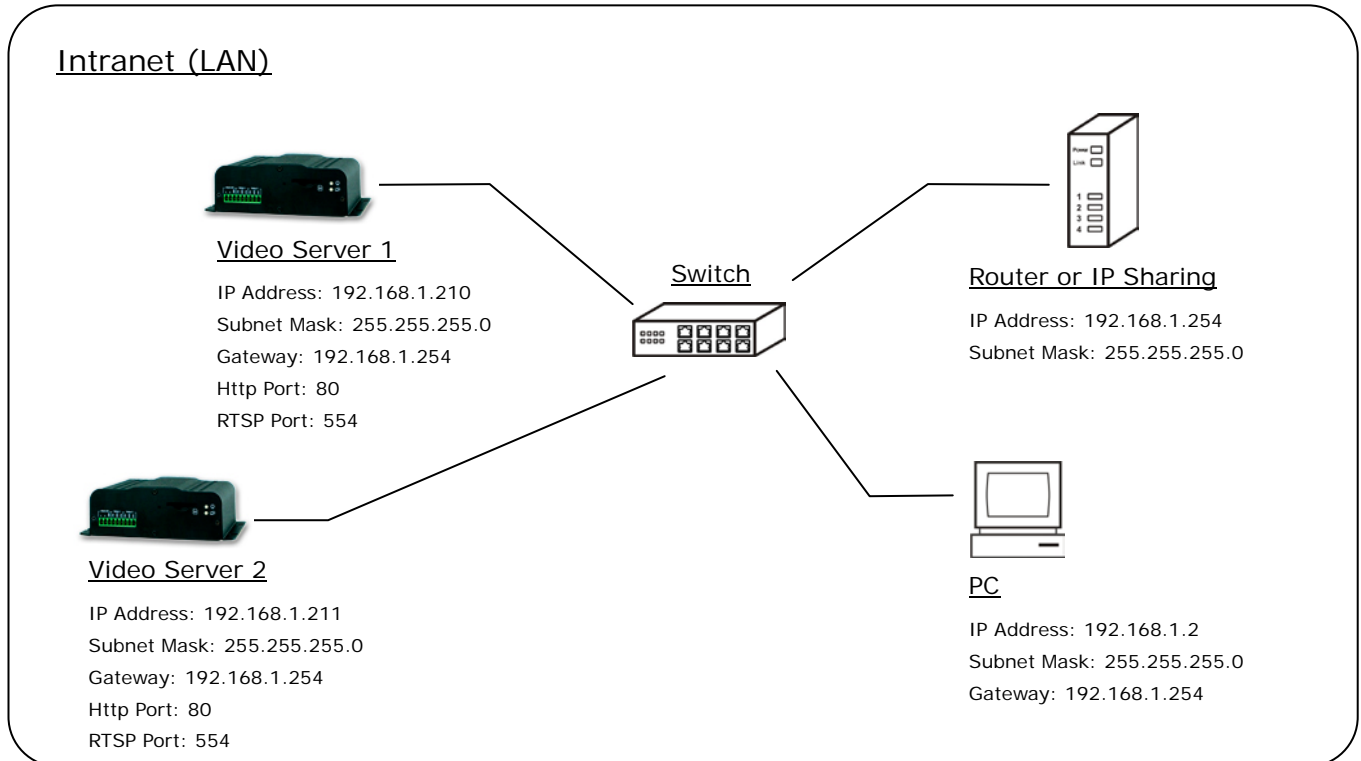

- Connect the video servers to the Switch.
- Refer to [Configuration → Network → Network](#) page to configure the IP settings.
- Please make sure the IP address of Router, PC and video servers are in the same subnet. Ex. [192.168.1.2](#) and [192.168.1.210](#) have the same subnet.
- Set Subnet Mask of Router, PC and video servers.
- Set Gateway of PC and video servers with the same IP address. Usually, the Gateway is the IP address of router.
- Set the IP address of a valid DNS into video servers. An invalid DNS will cause the domain name can't be resolved and reached, such as email address.

For example, if the IP settings have been configured as the above figure, the video servers can be linked with following addresses:

Client	Video Server	Link Address	Remark
PC	Video Server 1	http://192.168.1.210	
	Video Server 2	http://192.168.1.211	

B. Internet Only

Connects to ADSL with Fixed Public IP Address

If the video server connects to Internet with an ADSL modem and the public IP address of ADSL is fixed, please refer to the figure below for the connection.

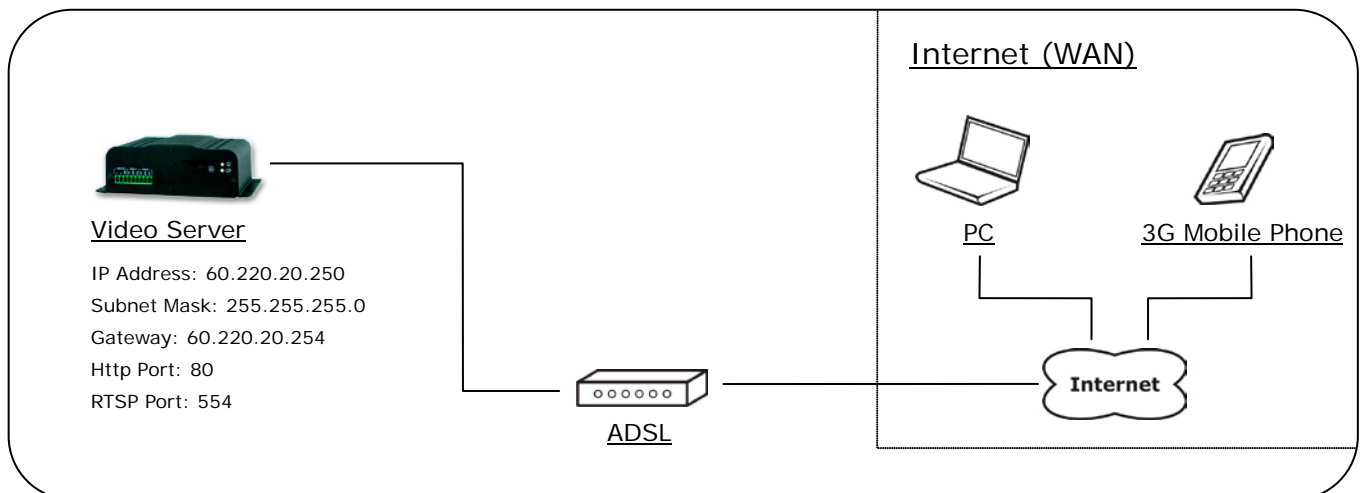

- Connect the video server to the ADSL modem.
- Refer to [Configuration → Network → Network](#) page, configure the IP address, Subnet Mask, Gateway and DNS with the settings that ISP provided for ADSL connection.

For example, if the public IP address is “60.220.20.250”, now the video server can be linked with following addresses:

Client	Link Address	Remark
PC	http://60.220.20.250	
3G Mobile Phone	With audio: rtsp://60.220.20.250/3g Without audio: rtsp://60.220.20.250/3gx	Must enable “3GPP Stream” in Configuration → Video/Audio → Video Format page

Connects to ADSL with Floating Public IP Address (PPPoE)

If the video server connects to Internet with an ADSL modem and the public IP address of ADSL is variable, the video server can use PPPoE function for the connection.

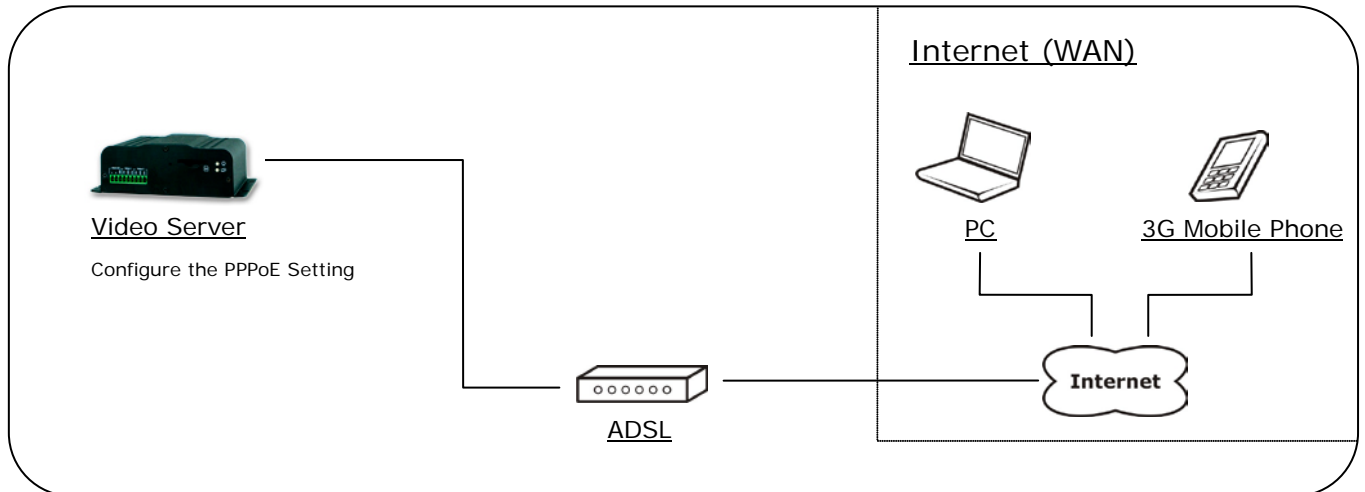

- Connect the video server to the ADSL modem.
- Refer to [Configuration → Network → PPPoE](#) page to configure the PPPoE settings.
- The video server will automatic dial-up and get the public IP address from ISP.
- If you have enable “Send Mail After Dialed” function, the video server will send an email to tell you the current public IP address.

For example, if the public IP address is “60.220.20.250”, now the video server can be linked with following addresses:

Client	Link Address	Remark
PC	http://60.220.20.250	
3G Mobile Phone	With audio: rtsp://60.220.20.250/3g Without audio: rtsp://60.220.20.250/3gx	Must enable “3GPP Stream” in Configuration → Video/Audio → Video Format page

Using DDNS Function

Since the public IP address is variable, you can enable DDNS function to get a fixed URL to instead of the IP address, refer to [Configuration → Network → DDNS](#) page to configure and enable the DDNS function.

After enable the DDNS, assume the registered URL is “test.dyndns.org”, now the video server can be linked with following URLs:

Client	Link Address	Remark
PC	http://test.dyndns.org	
3G Mobile Phone	With audio: rtsp://test.dyndns.org/3g Without audio: rtsp://test.dyndns.org/3gx	Must enable “3GPP Stream” in Configuration → Video/Audio → Video Format page

C. Intranet + Internet

Connects to Internet with Fixed Public IP Address

If the video server will be added into a local network (LAN), and will be accessed via both Intranet and Internet, please refer to the figure below for the connection.

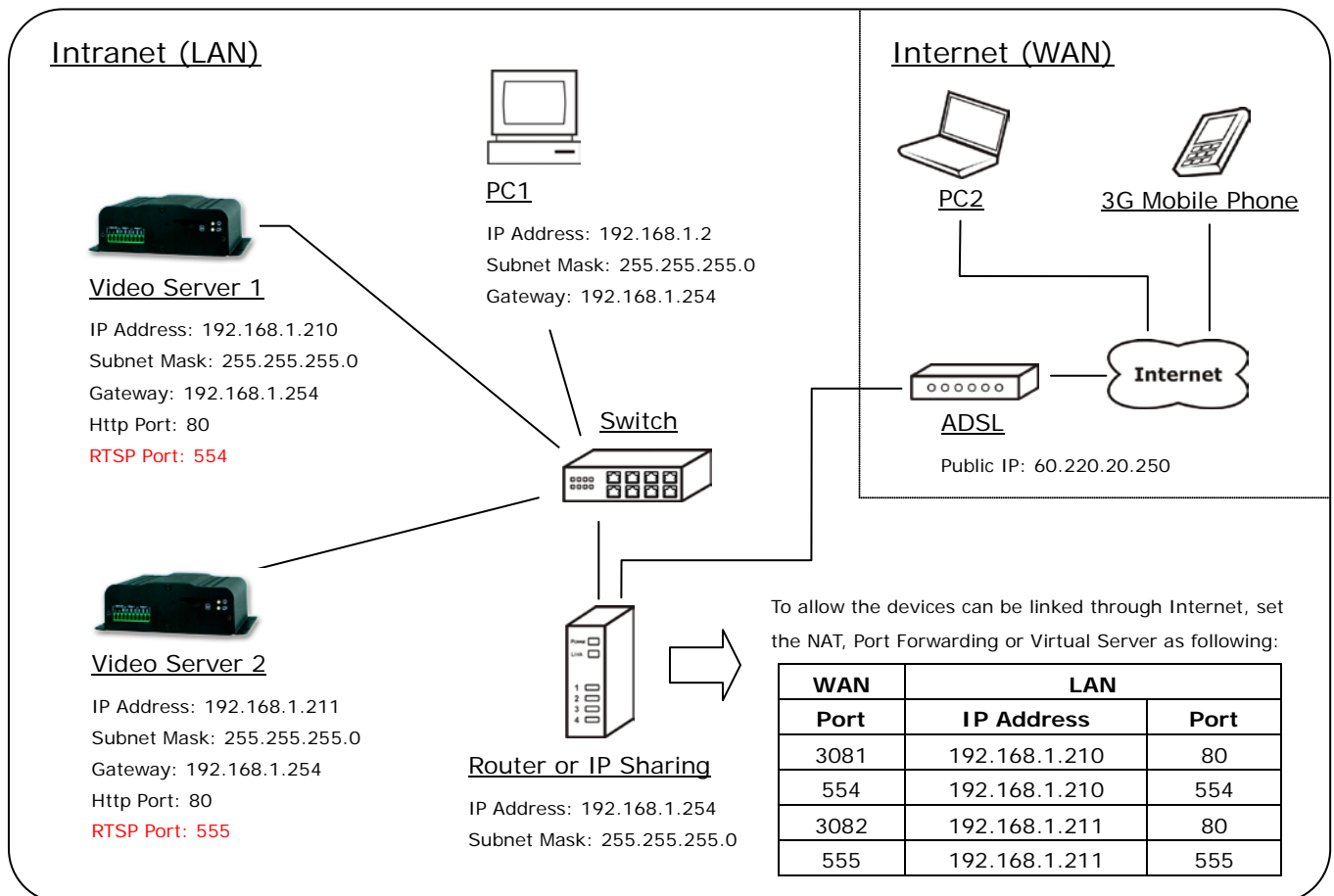

- Assume the local network will be connected to Internet with ADSL connection, first, configure the router (or IP sharing) with the ADSL connection. Please refer to the user's manual of router for the configuration.
- Connect the video servers to the Switch.
- Refer to [Configuration → Network → Network](#) page to configure the IP settings.
- Configure the video servers with different IP address. Ex. assign Video Server1 to 192.168.1.210, and assign Video Server2 to 192.168.1.211
- Please make sure the IP address of Router, PC and video servers are in the same subnet. Ex. 192.168.1.2 and 192.168.1.210 have the same subnet.

- Set Subnet Mask of Router, PC and video servers.
- Set Gateway of PC and video servers with the same IP address. The Gateway is the IP address of router.
- Set the IP address of a valid DNS into video servers. An invalid DNS will cause the domain name can't be resolved and reached, such as email address.
- Configure the video servers with different RTSP port. Ex. assign Video Server1 with port 554, and assign Video Server2 with port 555.
- To allow the video servers can be linked through Internet, set router's NAT (Network Address Translation), Port Forwarding or Virtual Server as following:

Video Server	WAN Side		LAN Side			Remark
	Port	Protocol	IP Address	Port	Protocol	
Video Server 1	3081	TCP	192.168.1.200	80	TCP	Port for Web page
	554	TCP	192.168.1.200	554	TCP	Port for Video and Audio
Video Server 2	3082	TCP	192.168.1.201	80	TCP	Port for Web page
	555	TCP	192.168.1.201	555	TCP	Port for Video and Audio

For example, if the IP settings have been configured as the above figure, the video servers can be linked with following addresses:

Clients in Intranet	Video Server	Link Address	Remark
PC1	Video Server 1	http://192.168.1.200	
	Video Server 2	http://192.168.1.201	

Client from Internet	Video Server	Link Address	Remark
PC2	Video Server 1	http://60.220.20.250:3081	
	Video Server 2	http://60.220.20.250:3082	
3G Mobile Phone	Video Server 1	With audio: rtsp://60.220.20.250:554/3g Without audio: rtsp://60.220.20.250:554/3gx	Must enable "3GPP Stream" in Configuration → Video/Audio → Video Format page

	Video Server 2	With audio: rtsp://60.220.20.250:555/3g Without audio: rtsp://60.220.20.250:555/3gx	
--	----------------	--	--

Connects to Internet with Floating Public IP Address

If the public IP address of ADSL connection is variable, you can enable DDNS function to get a fixed URL to instead of the IP address.

Note: only one device can enable the DDNS function in the local network (LAN), multiple devices use DDNS will update to the DDNS provider too frequently, and the DDNS provider will block your URL.

If the router has DDNS function, use router's DDNS function is recommended. Please refer to the user's manual of router for the configuration.

If the router doesn't have DDNS function, use one of the video servers DDNS function is recommended. Refer to [Configuration → Network → DDNS](#) page to configure and enable the DDNS function.

After enable the DDNS, assume the registered URL is "test.dyndns.org", now the video servers can be linked with following URLs:

Client from Internet	Video Server	Link Address	Remark
PC2	Video Server 1	http://test.dyndns.org:3081	
	Video Server 2	http://test.dyndns.org:3082	
3G Mobile Phone	Video Server 1	With audio: rtsp://test.dyndns.org:554/3g Without audio: rtsp://test.dyndns.org:554/3gx	Must enable "3GPP Stream" in Configuration → Video/Audio → Video Format page
	Video Server 2	With audio: rtsp://test.dyndns.org:555/3g Without audio: rtsp://test.dyndns.org:555/3gx	

7. Factory Default

To recover the default password and other settings, please follow the steps:

1. Power off this device.
2. Use a needle about 5cm long insert into the "Factory Default Hole" and push the button in the hole, keeping push it and don't release.

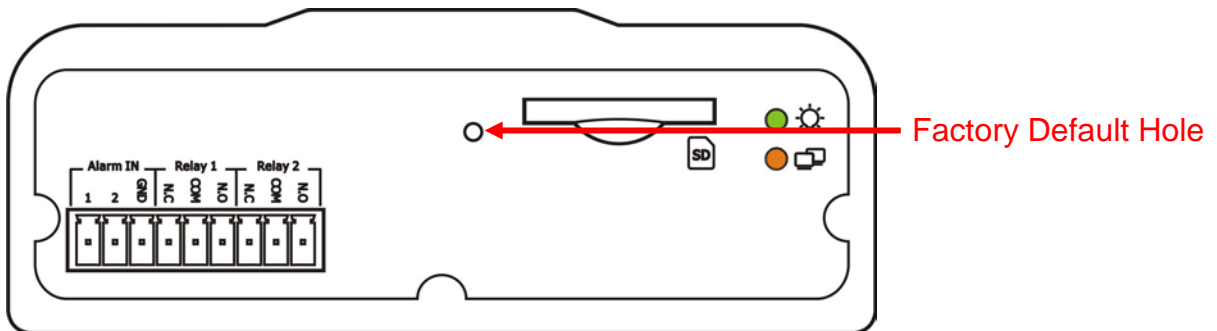

3. Power on the device. Don't release the button during the system booting.
4. It will take around 30 seconds to boot the device.
5. Release the button when the device finishes proceed.
6. Re-login the device using the default username (admin) and password (admin).
7. The IP address is probably restored to the default, in this case, use IP Search utility to search the device. The default IP address is 192.168.1.210

Compatible List of SD Card

The Compatible List of SD Card

Recommended SD Card	
SanDisk 128M	SanDisk 16G
SanDisk 256M	SanDisk 32G
SanDisk 512M	Transcend 4G
SanDisk 1G	Transcend 8G
SanDisk 2G	Transcend 16G
SanDisk 4G	Transcend 32G
SanDisk 8G	